

20 dBi Gain, 60.5-91.9 GHz, WR12 Standard Gain Horn with UG387/U-Mod Flange

Rev 1

Electrical

Frequency Range	60.5-91.9 GHz
Norminal Gain	20 dBi
Polarization	Linear
VSWR	1.2 max
3dB Beamwidth	E-Plane: 11.2~15.9 deg, H-Plane: 10.6~15.0 deg
Operating Temperature	-40°C~+70°C

Mechanical

Waveguide Size	WR12
Flange Type	UG387/U-Mod Round Cover Flange
Body Material and Finish	Copper, Gold Plated

Dimensions(mm)

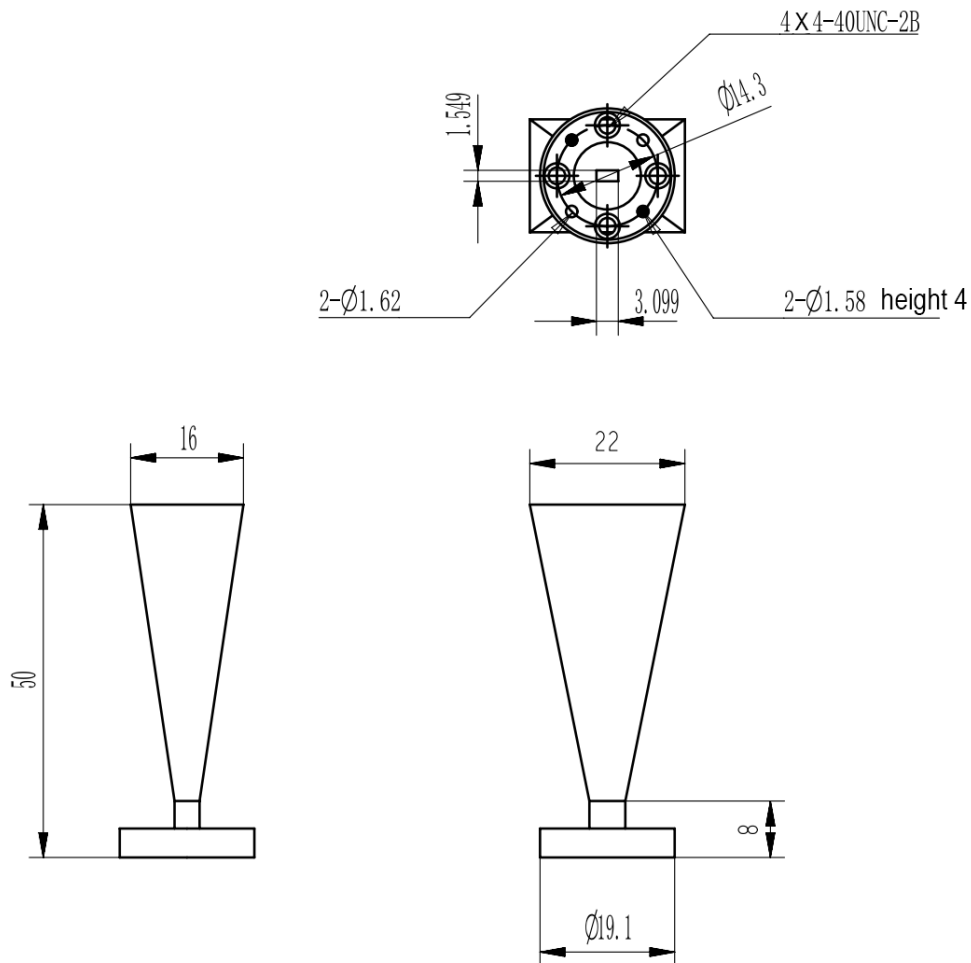

Simulated Antenna Patterns

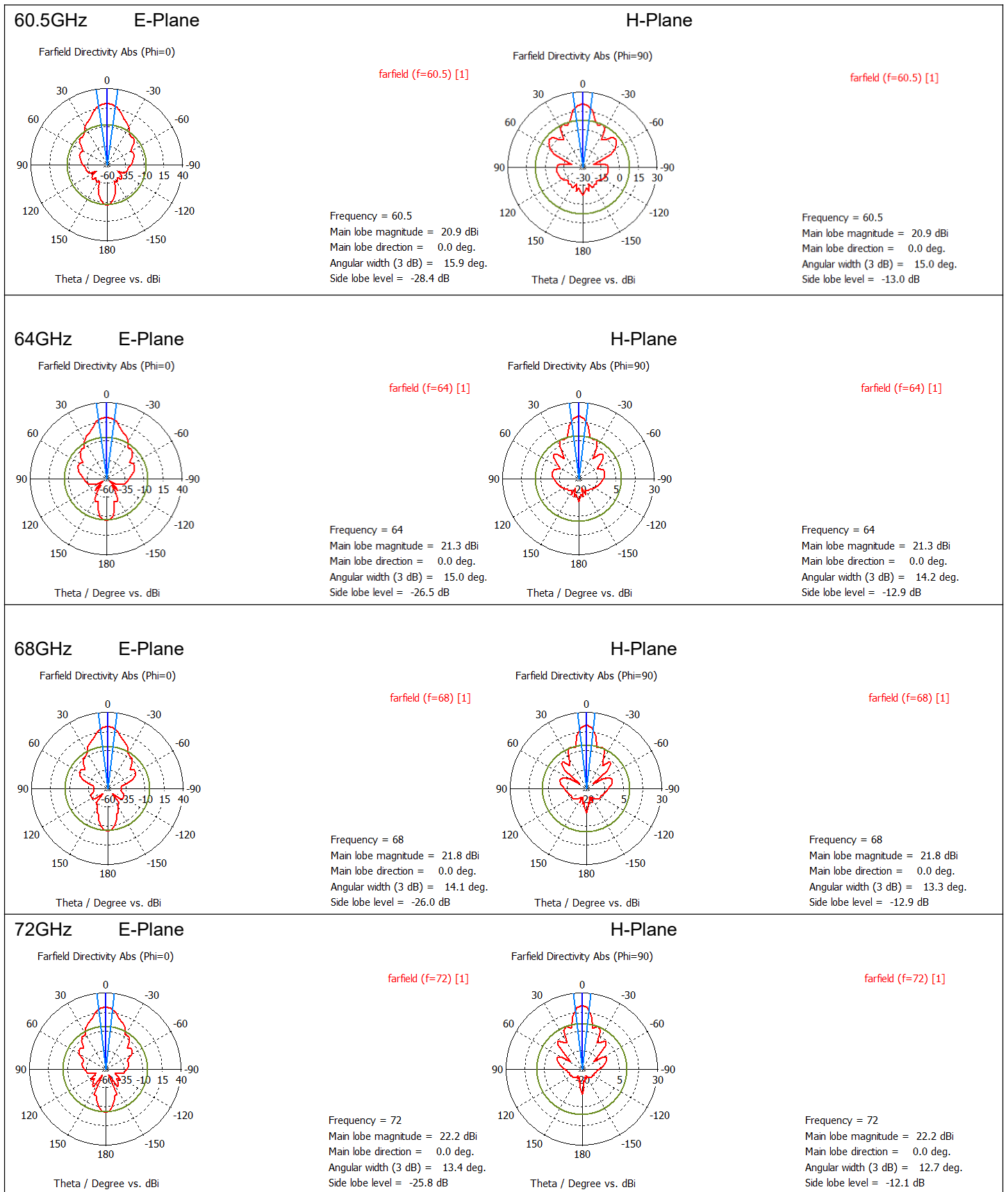

76GHz E-Plane

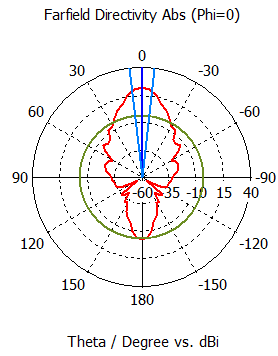

farfield (f=76) [1]

Frequency = 76
Main lobe magnitude = 22.6 dBi
Main lobe direction = 0.0 deg.
Angular width (3 dB) = 12.8 deg.
Side lobe level = -25.8 dB

H-Plane

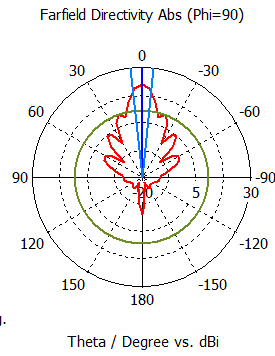

farfield (f=76) [1]

Frequency = 76
Main lobe magnitude = 22.6 dBi
Main lobe direction = 0.0 deg.
Angular width (3 dB) = 12.1 deg.
Side lobe level = -11.8 dB

80GHz E-Plane

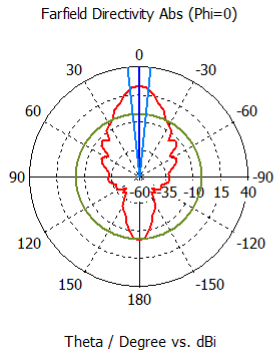

farfield (f=80) [1]

Frequency = 80
Main lobe magnitude = 23.0 dBi
Main lobe direction = 0.0 deg.
Angular width (3 dB) = 12.3 deg.
Side lobe level = -25.1 dB

H-Plane

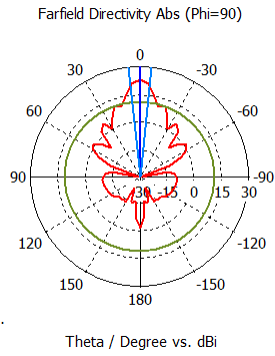

farfield (f=80) [1]

Frequency = 80
Main lobe magnitude = 23.0 dBi
Main lobe direction = 0.0 deg.
Angular width (3 dB) = 11.6 deg.
Side lobe level = -11.8 dB

84GHz E-Plane

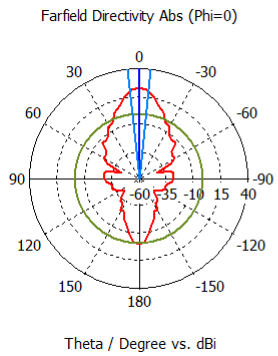

farfield (f=84) [1]

Frequency = 84
Main lobe magnitude = 23.2 dBi
Main lobe direction = 0.0 deg.
Angular width (3 dB) = 11.9 deg.
Side lobe level = -24.0 dB

H-Plane

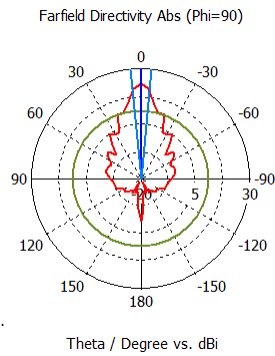

farfield (f=84) [1]

Frequency = 84
Main lobe magnitude = 23.2 dBi
Main lobe direction = 0.0 deg.
Angular width (3 dB) = 11.3 deg.
Side lobe level = -12.0 dB

88GHz E-Plane

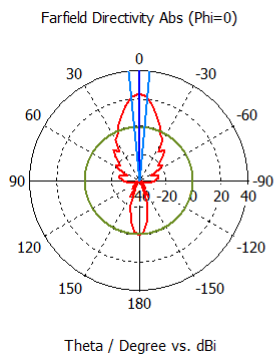

farfield (f=88) [1]

Frequency = 88
Main lobe magnitude = 23.6 dBi
Main lobe direction = 0.0 deg.
Angular width (3 dB) = 11.5 deg.
Side lobe level = -24.0 dB

H-Plane

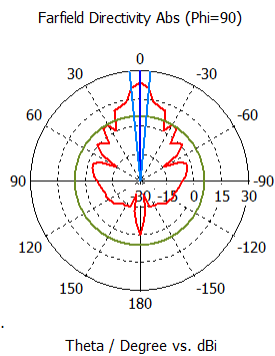

farfield (f=88) [1]

Frequency = 88
Main lobe magnitude = 23.6 dBi
Main lobe direction = 0.0 deg.
Angular width (3 dB) = 10.9 deg.
Side lobe level = -17.9 dB

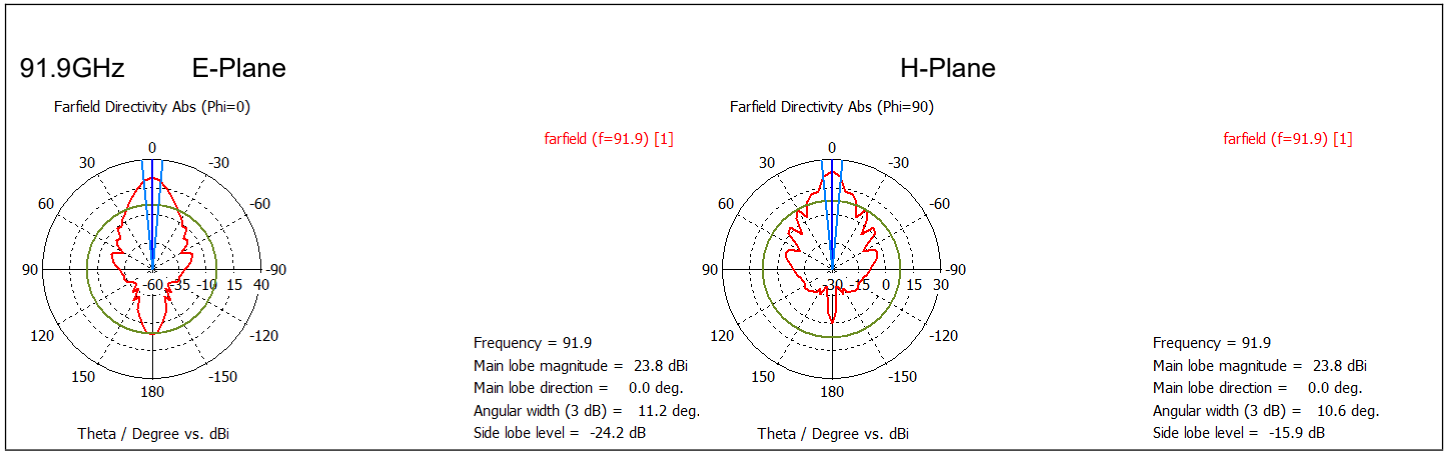

Typical Gain

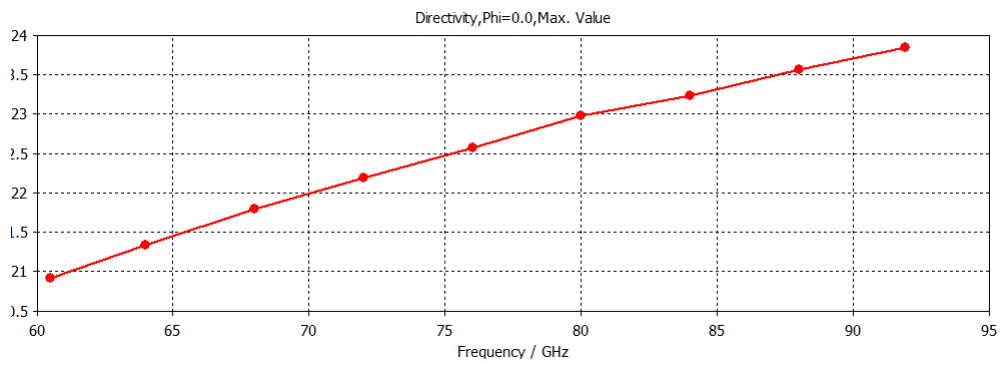

Typical VSWR

