

RADOX®

Coil winding industry

Edition 2015



RADOX[®] – for the toughest condition

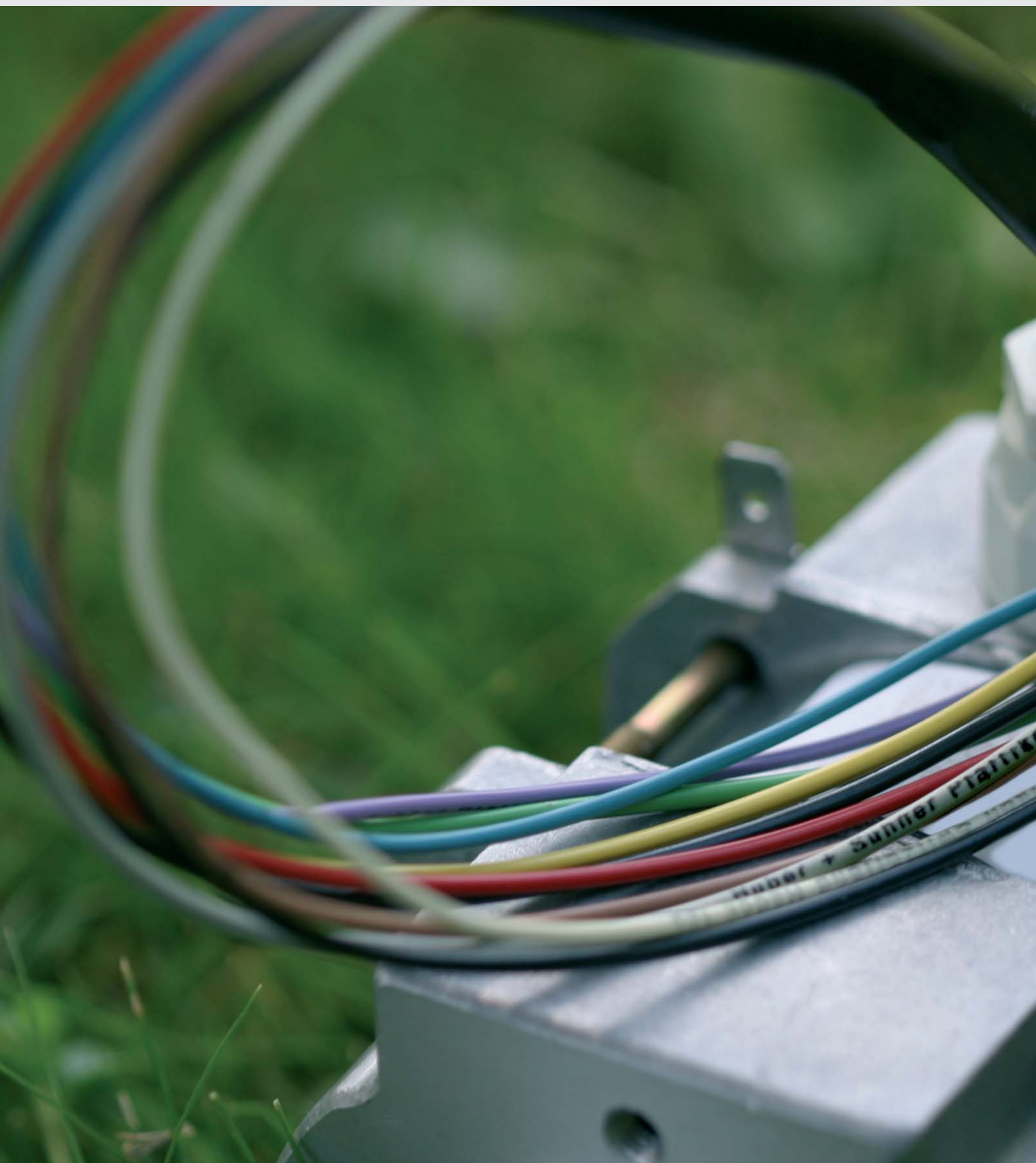



Your partner for connectivity solutions

Your partner for connectivity solutions HUBER+SUHNER is a leading global supplier of components and connectivity solutions for mobile communication systems. HUBER+SUHNER offers technical expertise in radio frequency, fibre optics and low frequency under a single roof, providing a broad range of products that can be relied on in the target markets communication, transportation and industrial.

RADOX®, the registered HUBER+SUHNER trademark, is synonymous with high-grade WIRE+CABLE products developed and produced in-house. RADOX insulating and jacketing materials, which are predominantly electron beam crosslinked, possess the special properties required for developing and manufacturing technically superior products. Its high temperature resistant, flame retardant, reduced wall thickness and easy processability make it the ideal insulating material for wires and cables in the coil winding industry.

We can also provide customer specific solutions.

Cable types for coil winding applications

Introduction	7
Flexible wires	9
Multicore cables	23
Technical information	37

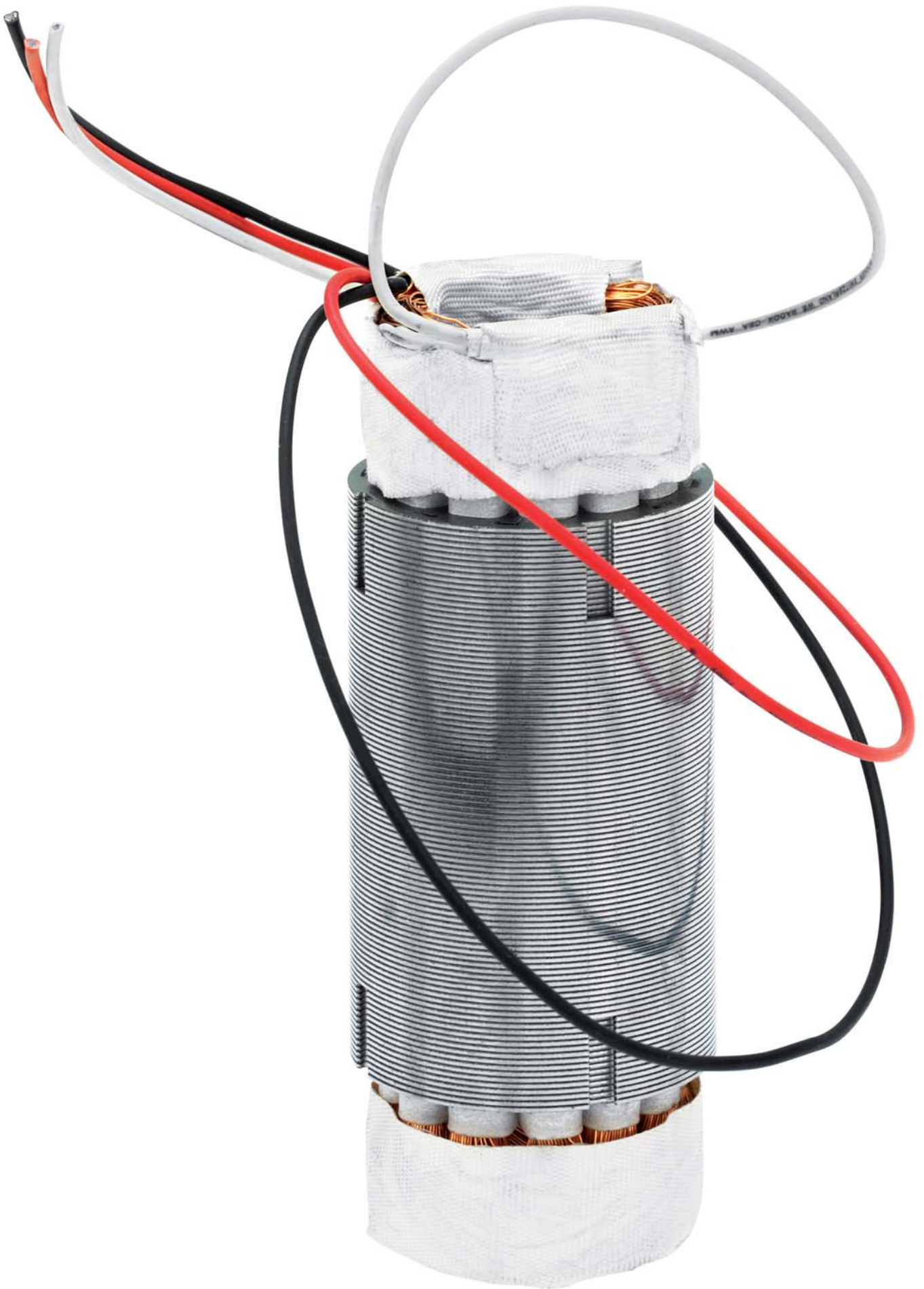

Introduction

Characteristics

- Broad temperature range
- Short circuit overload up to +250 °C
- High current carrying capacity
- Electron beam crosslinked
- Compatible with all common insulating varnishes and impregnation resins
- High resistance to thermal pressure, chemicals, hydrolysis and weathering
- Halogen free variants (low smoke, low toxicity)
- Flame retardant
- Soldering resistant and easy to strip
- Flexible
- Minimum outer diameter
- Standard range available from stock

Versatility

RADOX® cables and wires are used wherever optimum safety and reliability is called for under tough operating conditions:

- Coil winding
- Sensor connectors
- Electromagnets
- Transformers
- Heat sensors
- Pumps
- Solenoids
- Coils
- Relays
- Electrical systems

and many more...





RADOX® flexible wires

RADOX 125, flexible single core	10
RADOX 155, flexible	12
RADOX UL 3266/CSA AWM I A/B	14
RADOX UL 3271/CSA AWM I A/B	16
RADOX UL 3289/CSA CL 1503	18
RADOX KDJ-11, flexible	20

All our cables fully comply with the European directives 76/769/EWG, 2003/11/EG, 2000/53/EG, 2003/53/EG and 2011/65/EU (RoHS).

RADOX® 125

Flexible single core

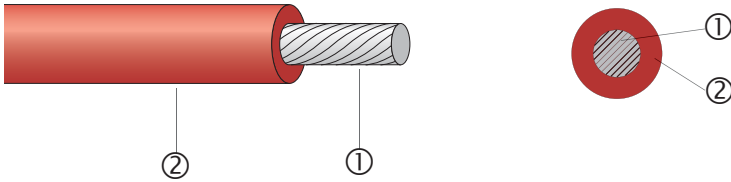

- Excellent high and low temperature and ozone resistance
- Weatherproof
- Halogen free
- Flexible, easy to strip and process
- High resistance to thermal pressure
- High abrasion resistance
- Oil-resistant

Application

Protected and fixed installation inside electrical equipment, especially suitable for the connection of motor windings, switchboards, white goods and lighting fixtures.

Composition of cable

- ① Conductor
- ② Insulation

Core colours

stranded tin plated copper, acc. to EN 60228, class 5
 RADOX 125
 extruded and electron beam crosslinked polyolefin copolymer
 various, on request

Technical data

Voltage rating U_0/U	< 0.75 mm ²	450/750 V AC
Test voltage	< 0.75 mm ²	2500 V AC
Voltage rating U_0/U	≥ 0.75 mm ²	600/1000 V AC
Test voltage	≥ 0.75 mm ²	3500 V AC
Temperature range		-40 up to +125 °C

The cables are in conformity with:

Halogen free compound	fulfilled	EN 50363
Corrosivity of combustion gases	pH ≥ 4.3, $\sigma \leq 10 \mu\text{S}/\text{mm}$	EN 50267-2-2
Amount of halogen acid gas	HCl + HBr ≤ 0.5 %	EN 50267-2-1
Content of fluorine	HF ≤ 0.1 %	EN 60684-2, # 45.2

RADOX® 125

Flexible single core

Extract from our delivery programme

Cross section	Conductor			Core	Weight	Bending radius
nom. mm ²	Construction nom. n × mm dia.	Dia. max. mm	R ₂₀ IEC 60228 max. Ω/km	Dia. mm	nom. kg/100 m	min.
0.25	19 × 0.13	0.6	85.9	1.45 ± 0.05	0.4	3 × dia.
0.34	19 × 0.16	0.8	52.1	1.60 ± 0.10	0.5	3 × dia.
0.50	19 × 0.18	0.9	40.1	1.70 ± 0.10	0.7	3 × dia.
0.75	24 × 0.20	1.15	26.7	2.20 ± 0.10	1.1	3 × dia.
1.0	32 × 0.20	1.3	20.0	2.60 ± 0.10	1.5	3 × dia.
1.5	30 × 0.25	1.55	13.7	2.73 ± 0.10	1.9	3 × dia.
2.5	48 × 0.25	2.05	8.21	3.50 ± 0.10	3.0	3 × dia.
4.0	56 × 0.30	2.6	5.09	4.15 ± 0.15	4.6	3 × dia.
6.0	82 × 0.30	3.4	3.39	4.95 ± 0.15	6.7	3 × dia.
10	78 × 0.40	4.4	1.95	6.15 ± 0.15	11	3 × dia.
16	119 × 0.40	5.4	1.24	7.35 ± 0.15	16.5	3 × dia.
25	182 × 0.40	6.7	0.795	8.9 ± 0.2	25	3 × dia.
35	266 × 0.40	7.9	0.565	10.3 ± 0.2	34.9	3 × dia.
50	378 × 0.40	9.4	0.393	12.1 ± 0.25	50	3 × dia.
70	348 × 0.50	11.5	0.277	14.4 ± 0.25	70.8	3 × dia.
95	444 × 0.50	12.9	0.210	16.0 ± 0.3	89	4 × dia.
120	570 × 0.50	15.1	0.164	18.6 ± 0.3	116	4 × dia.
150	722 × 0.50	17.0	0.132	20.5 ± 0.3	145	4 × dia.
185	874 × 0.50	18.5	0.108	22.2 ± 0.3	173	4 × dia.
240	1147 × 0.50	21.3	0.0817	25.4 ± 0.3	225	4 × dia.

Various colours on request.

RADOX® 155

Flexible single core

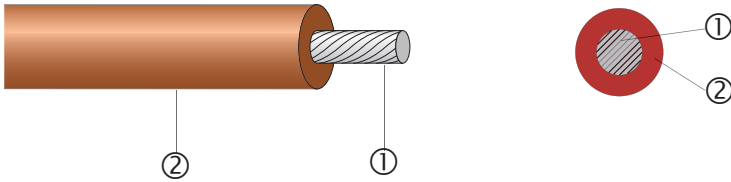

- Excellent high and low temperature and ozone resistance
- Weatherproof
- Easy to process
- High resistance to heat pressure
- High abrasion resistance
- Soldering resistant
- Flexible
- Resistant to impregnation resins and varnishes

Application

Protected and fixed installation inside electrical equipment, especially suitable for the connection of motor windings, switchboards, magnets and transformers.

Composition of cable

- ① Conductor
- ② Insulation

Core colours

stranded tin plated copper, acc. to EN 60228, class 5
RADOX 155
extruded and electron beam crosslinked polyolefin copolymer
various, on request

Technical data

Voltage rating U_0/U	< 0.75 mm ²	450/750 V AC
Test voltage	< 0.75 mm ²	2500 V AC
Voltage rating U_0/U	≥ 0.75 mm ²	600/1000 V AC
Test voltage	≥ 0.75 mm ²	3500 V AC
Temperature range		-55 up to +155 °C

RADOX® 155

Flexible single core

Extract from our delivery programme

Cross section	Conuctor			Core	Weight	Bending radius
nom. mm ²	Construction nom. n × mm dia.	Dia. max. mm	R ₂₀ IEC 60228 max. Ω/km	Dia. mm	nom. kg/100 m	min.
0.25	19 × 0.13	0.6	86.0	1.45 ± 0.05	0.4	3 × dia.
0.34	19 × 0.16	0.8	53.1	1.60 ± 0.10	0.5	3 × dia.
0.50	19 × 0.18	0.9	40.1	1.71 ± 0.10	0.7	3 × dia.
0.75	24 × 0.20	1.15	26.7	2.25 ± 0.10	1.1	3 × dia.
1.0	32 × 0.20	1.3	20.0	2.50 ± 0.10	1.5	3 × dia.
1.5	30 × 0.25	1.55	13.7	2.85 ± 0.10	1.9	3 × dia.
2.5	48 × 0.25	2.05	8.21	3.50 ± 0.10	3.0	3 × dia.
4.0	56 × 0.30	2.6	5.09	4.20 ± 0.15	4.5	3 × dia.
6.0	82 × 0.30	3.0	3.39	5.0 ± 0.15	6.5	3 × dia.
10	78 × 0.40	3.9	1.95	6.4 ± 0.15	11	3 × dia.
16	119 × 0.40	5.4	1.24	7.6 ± 0.15	16.5	3 × dia.
25	182 × 0.40	6.7	0.795	9.2 ± 0.2	25	3 × dia.
35	266 × 0.40	7.9	0.565	10.7 ± 0.3	36.3	3 × dia.
50	378 × 0.40	9.4	0.393	12.3 ± 0.3	50	4 × dia.
70	348 × 0.50	11.5	0.277	14.6 ± 0.3	68	4 × dia.
95	444 × 0.50	13.0	0.210	16.4 ± 0.3	89	4 × dia.
120	570 × 0.50	15.4	0.164	18.5 ± 0.3	110	4 × dia.
150	722 × 0.50	17.0	0.132	20.8 ± 0.3	142	4 × dia.
185	874 × 0.50	18.5	0.108	22.7 ± 0.3	171	4 × dia.
240	1147 × 0.50	21.3	0.0817	26.1 ± 0.4	225	4 × dia.

Various colours on request.

RADOX® UL 3266/CSA AWM I A/B

Flexible single core

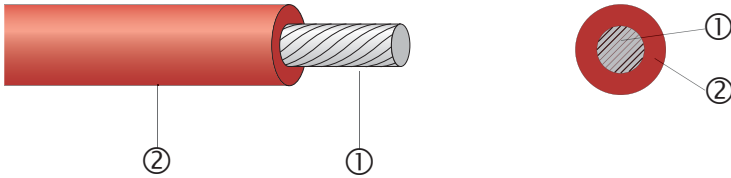

- Excellent high and low temperature and ozone resistance
- Weatherproof
- High abrasion resistance
- Resistant to impregnation resins and varnishes
- Easy to process
- Soldering resistant
- Flexible

Application

Protected and fixed installation inside electrical equipment, especially suitable for the connection of motor windings, switchboards, magnets and transformers.

Composition of cable

① Conductor	stranded tin plated copper, acc. to EN 60228, class 5
② Insulation	RADOX extruded and electron beam crosslinked polyolefin copolymer
Core colours	various, on request

Technical data

Voltage rating U_o/U		300 V AC
Test voltage		2000 V AC
Operating temperature		+125 °C
Max. conductor temperature	at short circuit (max. 5 s)	+280 °C
Min. operating temperature	flexing	-25 °C
	fixed	-40 °C
Min. bending radius		3 × core-dia.

Standards

Appliance wiring material	CSA C22.2 no. 210.2	AWM I A/B 125 °C 300 V
Appliance wiring material	UL 758	style 3266

Approvals

UL	Underwriters Laboratories	file no. E63322
CSA	Canadian Standards Association	report no. 69581

The cables pass the following fire tests:

Vertical flame spread FT2	$L \leq 100$ mm	CSA C22.2 no. 0.3 # 4.11.2
Horizontal flame spread, Appliance-wire	$V \leq 25$ mm/Min.	UL 1581 # 1090

RADOX® UL 3266/CSA AWM I A/B

Flexible single core

Extract from our delivery programme

Cross section		Conductor		Core	Weight
nom.		Construction n × mm dia.	Dia. max. mm	Dia. mm	nom. kg/100 m
AWG	mm ²				
26	0.15	19 × 0.10	0.51	1.32 ± 0.05	0.32
24	0.25	19 × 0.13	0.61	1.45 ± 0.05	0.41
22	0.38	19 × 0.16	0.77	1.65 ± 0.10	0.53
20	0.62	19 × 0.20	0.99	1.85 ± 0.10	0.83
18	0.96	19 × 0.25	1.23	2.10 ± 0.10	1.13
(16)	1.5	19 × 0.31	1.52	2.41 ± 0.10	1.65
14	2.1	19 × 0.37	1.86	2.72 ± 0.10	2.33
12	3.3	37 × 0.35	2.35	3.21 ± 0.10	3.53
10	5.26	37 × 0.44	3.02	3.88 ± 0.10	5.61

Various colours on request.

RADOX® UL 3271/CSA AWM I A/B

Flexible single core

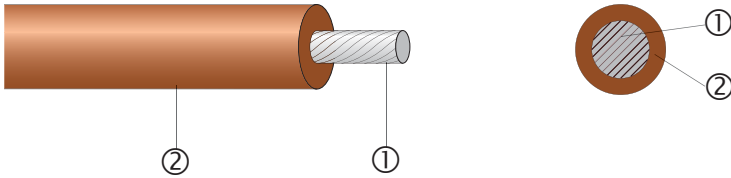

- Excellent high and low temperature and ozone resistance
- Weatherproof
- Flame retardant
- High resistance to heat pressure
- High abrasion resistance
- Easy to process
- Soldering resistant
- Flexible

Application

Protected and fixed installation inside electrical equipment, especially suitable for the connection of motor windings, switchboards, magnets and transformers.

Composition of cable

- ① Conductor
- ② Insulation

Core colours

stranded tin plated copper, acc. to EN 60228, class 5
 RADOX
 extruded and electron beam crosslinked polyolefin copolymer
 various, on request

Technical data

Voltage rating		600 V AC
Test voltage		2500 V AC
Operating temperature	(UL/CSA temperature rating)	+125 °C
Max. conductor temperature	at short circuit (max. 5 s)	+280 °C
Min. operating temperature	flexing	-25 °C
	fixed	-40 °C

Standards

Appliance wiring material	CSA C22.2 no. 210.2	AWM I A/B 125 °C 600 V FT2
Appliance wiring material	UL 758	style 3271

Approvals

UL	Underwriters Laboratories	file no. E63322
CSA	Canadian Standards Association	certificate no. 1418425

RADOX® UL 3271/CSA AWM I A/B

Flexible single core

The cables pass the following fire tests:

Vertical flame spread FT1	L ≤ 250 mm, t ≤ 60 s	CSA C22.2 no. 0.3 # 4.11.1
Horizontal flame spread FT2	L ≤ 100 mm	CSA C22.2 no. 0.3 # 4.11.2
Vertical flame spread	50 < L ≤ 540 mm	EN 60332-1-2, IEC 60332-1-2
Horizontal flame spread,		
Appliance-wire	V ≤ 25 mm/Min.	UL 1581 # 1090
Vertical flame spread, VW-1	L ≤ 250 mm, t ≤ 60 s	UL 1581 # 1080

Extract from our delivery programme

Cross section		Conductor			Core	Weight	Bending radius
nom.		Construction nom. n × mm dia.	Dia. max. mm	R ₂₀ IEC 60228 max. Ω/km	Dia. mm	nom. kg/100 m	min.
AWG	mm ²						
24	(0.25)	19 × 0.13	0.61	84.2	2.22 ± 0.10	0.72	3 × dia.
22	(0.38)	19 × 0.16	0.77	52.1	2.40 ± 0.10	0.92	3 × dia.
20	(0.62)	19 × 0.20	0.99	31.8	2.60 ± 0.10	1.2	3 × dia.
18	(0.96)	19 × 0.25	1.23	20.2	2.85 ± 0.10	1.6	3 × dia.
(16)	1.5	19 × 0.31	1.52	12.9	3.20 ± 0.10	2.1	3 × dia.
14	(2.1)	19 × 0.37	1.86	8.8	3.50 ± 0.10	2.9	3 × dia.
12	(3.3)	37 × 0.35	2.35	5.53	4.0 ± 0.15	4.2	3 × dia.
10	(5.26)	37 × 0.44	3.02	3.34	4.7 ± 0.15	6.4	3 × dia.
(8)	10	80 × 0.40	4.3	1.91	6.4 ± 0.15	12.1	3 × dia.
(6)	16	119 × 0.40	5.4	1.22	8.6 ± 0.2	18.8	3 × dia.
(4)	25	182 × 0.40	6.7	0.795	9.9 ± 0.2	26.8	3 × dia.
(2)	35	266 × 0.40	7.9	0.554	11.1 ± 0.2	36.4	3 × dia.
(1)	50	378 × 0.40	9.4	0.385	13.7 ± 0.25	54.3	4 × dia.
(2/0)	70	348 × 0.50	11.5	0.271	15.8 ± 0.25	72.3	4 × dia.
(3/0)	95	444 × 0.50	13.0	0.206	17.4 ± 0.3	95.5	4 × dia.
(4/0)	120	551 × 0.50	15.1	0.164	19.3 ± 0.3	116	4 × dia.
	150	722 × 0.50	17.0	0.132	22.2 ± 0.3	150	4 × dia.

Various colours on request.

RADOX® UL 3289/CSA CL 1503

Flexible single core

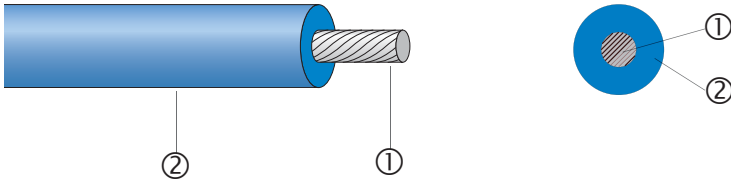

- Excellent high and low temperature and ozone resistance
- Weatherproof
- Flame retardant
- High resistance to heat pressure
- High abrasion resistance
- Easy to process
- Soldering resistant
- Flexible
- Resistant to impregnation resins and varnishes

Application

Protected and fixed installation inside electrical equipment, especially suitable for the connection of motor windings, switchboards, magnets and transformers.

Composition of cable

① Conductor	stranded tin plated copper, acc. to EN 60228, class 5
② Insulation	RADOX 155 extruded and electron beam crosslinked polyolefin copolymer
Core colours	various, on request

Technical data

Voltage rating	600 V AC
Test voltage	2500 V AC
Operating temperature	+150 °C
Max. conductor temperature	at short circuit (max. 5 s) +280 °C
Min. operating temperature	flexing -40 °C fixed -55 °C

Standards

Appliance wiring material	CSA	CL 1503
Appliance wiring material	UL 758	style 3289

Approvals

UL	Underwriters Laboratories	file no. E63322
CSA	Canadian Standards Association	certificate no. 039507

RADOX® UL 3289/CSA CL 1503

Flexible single core

Extract from our delivery programme

Cross section		Conductor		Core	Weight	Bending radius
nom.		Construction nom. n × mm dia.	Dia. max. mm	Dia. mm	nom. kg/100 m	min.
AWG	mm ²					
26	0.149	19 × 0.10	0.51	2.13 ± 0.10	0.55	3 × dia.
24	0.205	19 × 0.13	0.61	2.27 ± 0.10	0.66	3 × dia.
22	0.324	19 × 0.16	0.79	2.40 ± 0.10	0.79	3 × dia.
20	0.519	19 × 0.20	0.99	2.61 ± 0.10	1.1	3 × dia.
18	0.823	19 × 0.25	1.23	2.85 ± 0.10	1.5	3 × dia.
(16)	1.50	19 × 0.31	1.55	3.20 ± 0.10	2.1	3 × dia.
14	2.08	19 × 0.37	1.86	3.50 ± 0.10	2.7	3 × dia.
12	3.31	37 × 0.34	2.35	4.00 ± 0.15	4.0	3 × dia.
10	5.26	37 × 0.43	3.02	4.68 ± 0.15	6.1	3 × dia.
(8)	10	80 × 0.40	3.94	6.40 ± 0.15	11.7	3 × dia.
(6)	16	119 × 0.40	5.4	8.90 ± 0.2	18.4	3 × dia.
(4)	25	182 × 0.40	6.7	10.2 ± 0.2	25.8	3 × dia.
(2)	35	266 × 0.40	7.9	11.4 ± 0.2	36.5	3 × dia.
(1)	50	378 × 0.40	9.4	14.0 ± 0.25	54.3	4 × dia.
(2/0)	70	348 × 0.50	11.5	16.1 ± 0.3	71.3	4 × dia.
(3/0)	95	444 × 0.50	12.9	17.6 ± 0.3	93.6	4 × dia.
(4/0)	120	551 × 0.50	14.8	19.3 ± 0.3	113	4 × dia.

Various colours on request.

RADOX® KDJ-11

Flexible single core

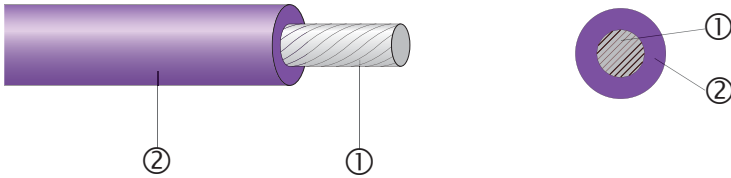

- Resistant to solvents, oils, fuels, alkaline solutions, acids and hydrolysis
- Weatherproof
- Impermeable to vapour
- Compact design
- Mechanical robustness in aggressive environment at high and low temperatures

Application

- Wiring of equipment for heating and refrigeration units, chemical plants, wet or humid rooms and rooms with high ambient temperatures.
- Compatible to moulding compounds.
- Transformer in oil, class H motors.

Composition of cable

① Conductor	stranded bare copper, acc. to EN 60228, class 5
② Insulation	FEP
Core colours	various, on request

Technical data

Voltage rating U_0/U	0.50 and 1.0 mm ²	300/500 V AC
	1.50 up to 25 mm ²	450/750 V AC
Test voltage		2500 V AC
Max. conductor temperature	(continuous)	+180 °C
Short circuit temperature	(max. 5 s)	+250 °C
Min. operating temperature	fixed	-100 °C
	flexing	-55 °C
Min. bending radius	fixed	3 × core-dia.
	flexing	5 × core-dia.

RADOX® KDJ-11

Flexible single core

Extract from our delivery programme

Cross section	Conductor			Core	Weight
nom. mm ²	Construction nom. n × mm dia.	Dia. max. mm	R ₂₀ IEC 60228 max. Ω/km	Dia. mm	nom. kg/100 m
0.50	19 × 0.18	0.91	37.1	1.85	0.8
0.75	24 × 0.20	1.16	24.7	2.10	1.2
1.0	32 × 0.20	1.33	18.5	2.30	1.4
1.5	19 × 0.32	1.63	12.6	2.60	2.0
2.5	50 × 0.25	1.98	7.58	3.20	3.0
4.0	56 × 0.30	2.50	4.70	3.80	4.3
6.0	84 × 0.30	2.98	3.14	4.90	6.8
10	80 × 0.40	3.94	1.87	5.50	11.1

Various colours on request.

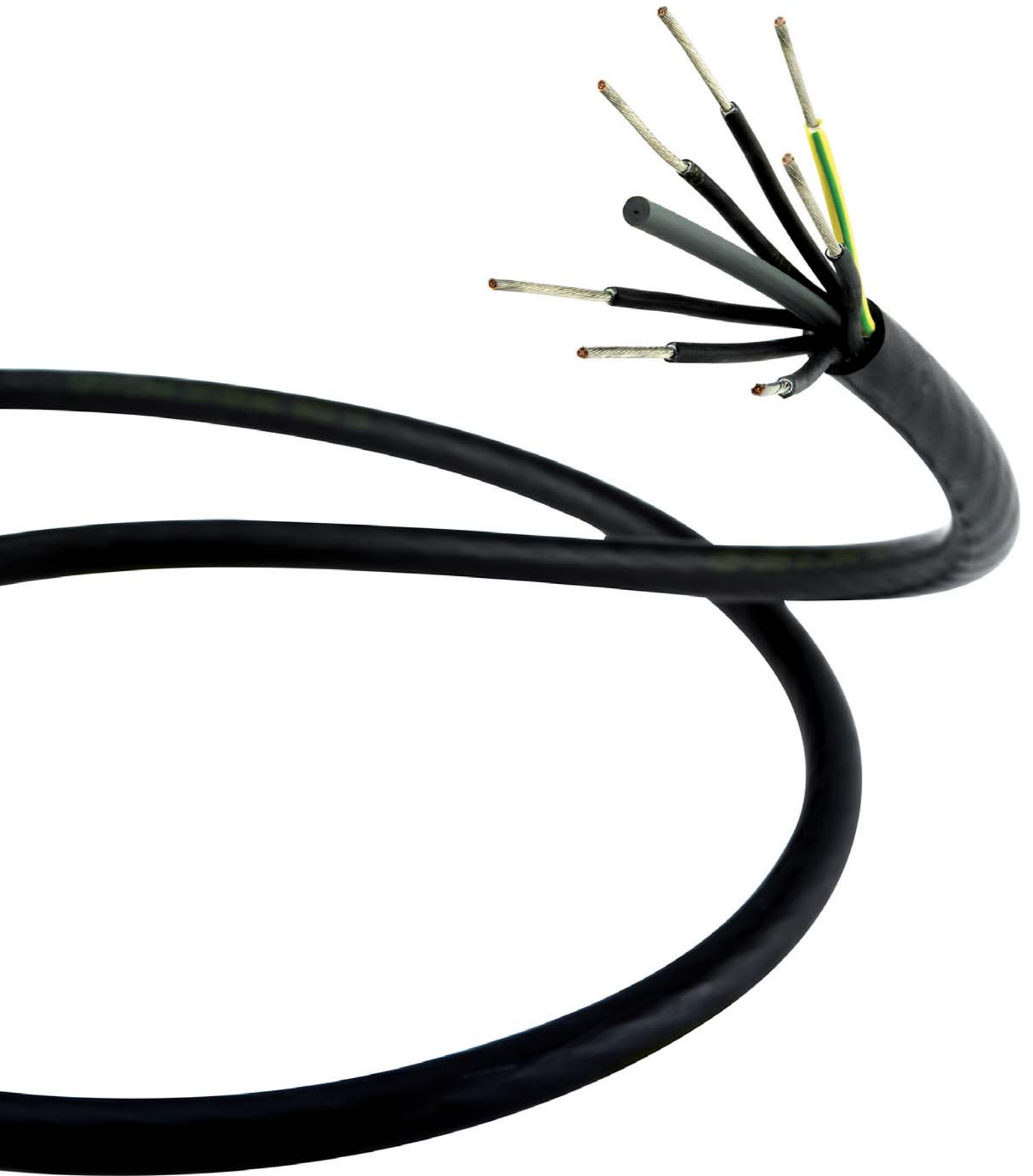

RADOX® multicore cables

RADOX 155	24
RADOX 155, screened	26
RADOX UL4486/CSA AWM I/II A/B 300 V	28
RADOX UL4486/CSA AWM I/II A/B 300 V, screened	30
RADOX UL4486/CSA AWM I/II A/B 600 V	32
RADOX UL4486/CSA AWM I/II A/B 600 V, screened	34

All our cables fully comply with the European directives 76/769/EEG, 2003/11/EG, 2000/53/EG, 2003/53/EG and 2011/65/EU (RoHS).

RADOX® 155

Multi core cable

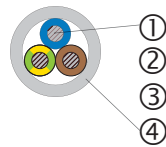
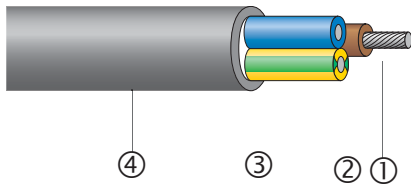

- Excellent high and low temperature and ozone resistance
- Weatherproof
- Flame retardant
- Soldering resistant
- Flexible
- Easy to strip

Application

Permanent installation indoor and outdoor for the connection of fixed and loose parts.

Composition of cable

① Core:	
Conductor	stranded tin plated copper, acc. to EN 60228, class 5
Insulation	RADOX 155 extruded and electron beam crosslinked polyolefin copolymer
Core colours	2 up to 5 core acc. to CENELEC HD 308 (see page 43) 6 core and more: black numbered with yellow-green earthing other colours on request
② Fillers (optional)	RADOX 125
③ Separator (optional)	plastic tape
④ Sheath	RADOX 155 extruded and electron beam crosslinked polyolefin copolymer
Colour	black

Technical data

Voltage rating U_0/U	$\leq 16 \times 0.50 \text{ mm}^2$	450/750 V AC
Test voltage	$\leq 16 \times 0.50 \text{ mm}^2$	2500 V AC
Voltage rating U_0/U	$> 16 \times 0.50 \text{ mm}^2$	600/1000 V AC
Test voltage	$> 16 \times 0.50 \text{ mm}^2$	3500 V AC
Temperature range	fixed	-55 up to +155 °C
Min. operating temperature	flexible	-40 °C
Max. conductor temperature	at short circuit (max. 5 s)	+280 °C
Min. bending radius	fixed	3 × cable-dia.
	flexible	5 × cable-dia.

RADOX® 155

Multi core cable

Extract from our delivery programme

Cross section n × mm ²	Conductor			Core	Cable	Weight
	Construction nom. n × mm dia.	Dia. max. mm	R ₂₀ IEC 60228 max. Ω/km	Dia. mm	Dia. mm	nom.
4 × 0.25	19 × 0.13	0.6	85.9	1.45 ± 0.05	5.4 ± 0.3	3.3
3 × 0.34	19 × 0.15	0.75	57.2	1.55 ± 0.10	5.1 ± 0.3	-
2 × 0.50	19 × 0.18	0.9	40.1	1.7 ± 0.10	5.2 ± 0.3	-
3 × 0.50	19 × 0.18	0.9	40.1	1.7 ± 0.10	5.6 ± 0.3	4.0
8 × 0.50	19 × 0.18	0.9	40.1	1.7 ± 0.10	8.75 ± 0.3	-
16 × 0.50	19 × 0.18	0.9	40.1	1.7 ± 0.10	10.4 ± 0.4	-
3 × 0.75	24 × 0.20	1.15	26.7	2.2 ± 0.10	6.7 ± 0.3	5.9
4 × 0.75	24 × 0.20	1.15	26.7	2.2 ± 0.10	7.5 ± 0.3	-
2 × 1.0	32 × 0.20	1.3	20.0	2.6 ± 0.10	7.0 ± 0.3	6.1
3 × 1.0	32 × 0.20	1.3	20.0	2.6 ± 0.10	7.6 ± 0.3	7.7
2 × 1.5	30 × 0.25	1.55	13.7	2.7 ± 0.10	7.5 ± 0.3	6.6
3 × 1.5	30 × 0.25	1.55	13.7	2.7 ± 0.10	7.9 ± 0.3	9.2
4 × 1.5	30 × 0.25	1.55	13.7	2.7 ± 0.10	8.8 ± 0.3	11.7
5 × 1.5	30 × 0.25	1.55	13.7	2.7 ± 0.10	10.1 ± 0.4	15.0
3 × 2.5	50 × 0.25	2.05	8.21	3.35 ± 0.10	9.9 ± 0.3	14.6
4 × 2.5	50 × 0.25	2.05	8.21	3.35 ± 0.10	11.0 ± 0.4	18.6
5 × 2.5	50 × 0.25	2.05	8.21	3.35 ± 0.10	11.9 ± 0.4	22.3

Other cross sections on request.

RADOX® 155

Multi core cable – screened

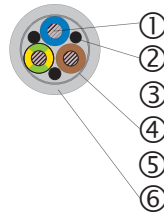
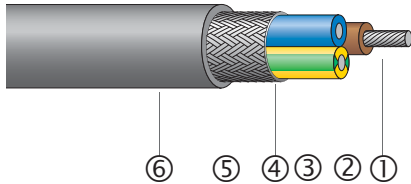

- Excellent high and low temperature and ozone resistance
- Weatherproof
- Flame retardant
- Soldering resistant
- Flexible
- Easy to strip

Application

Permanent installation indoor and outdoor for the connection of fixed and loose parts.

Composition of cable

① Core:	
Conductor	stranded tin plated copper, acc. to EN 60228, class 5
Insulation	RADOX 155 extruded and electron beam crosslinked polyolefin copolymer
Core colours	2 up to 5 core acc. to CENELEC HD 308 (see page 43) 6 core and more: black numbered with yellow-green earthing other colours on request
② Fillers (optional)	RADOX 125
③ Separator (optional)	plastic tape
④ Screen	copper braid, optical coverage: $\geq 85\%$
⑤ Separator (optional)	plastic tape
⑥ Sheath	RADOX 155
Colour	extruded and electron beam crosslinked polyolefin copolymer black

Technical data

Voltage rating U_0/U	$\leq 16 \times 0.50 \text{ mm}^2$	450/750 V AC
Test voltage	$\leq 16 \times 0.50 \text{ mm}^2$	2500 V AC
Voltage rating U_0/U	$> 16 \times 0.50 \text{ mm}^2$	600/1000 V AC
Test voltage	$> 16 \times 0.50 \text{ mm}^2$	3500 V AC
Temperature range	fixed	-55 up to +155 °C
Min. operating temperature	flexible	-40 °C
Max. conductor temperature	at short circuit (max. 5 s)	+280 °C
Min. bending radius	fixed	4 × cable-dia.
	flexible	5 × cable-dia.

Fire tests

Flame propagation:		
Vertical of a single cable	EN 50265-2-1, IEC 60332-1	
Vertical of bunched cables	DIN EN 50266-2-5	category D

RADOX® 155

Multi core cable – screened

Extract from our delivery programme

Cross section	Conductor			Core	Screen	Cable	Weight
	n × mm ²	Construction nom. n × mm dia.	Dia. max. mm				
2 × 0.25	19 × 0.12	0.61	88.5	1.45 ± 0.05	3.35	5.1 ± 0.3	3.43
6 × 0.25	19 × 0.12	0.61	88.5	1.45 ± 0.05	5.07	6.95 ± 0.15	6.71
4 × 2 × 0.25	19 × 0.12	0.61	88.5	1.45 ± 0.05	11.2	14.0 ± 0.4	27.7
4 × 0.5	19 × 0.18	0.9	40.1	1.71 ± 0.10	5.55	7.6 ± 0.15	7.62
16 × 0.5	19 × 0.18	0.9	40.1	1.71 ± 0.10	9.0	11.6 ± 0.4	20.3
3 G 1.5	30 × 0.25	1.61	13.3	2.73 ± 0.10	6.6	8.7 ± 0.3	11.6
10 G 1.5	30 × 0.25	1.61	13.3	2.73 ± 0.10	11.9	14.7 ± 0.4	33.2
26 G 1.5	30 × 0.25	1.61	13.3	2.73 ± 0.10	18.0	22.0 ± 0.5	74.1
8 G 2.5	50 × 0.25	2.06	8.6	3.5 ± 0.10	14.5	17.9 ± 0.5	49.8
9 G 2.5	50 × 0.25	2.06	8.6	3.5 ± 0.10	15.1	18.6 ± 0.5	51.8

Other cross sections on request.

RADOX® UL4486/CSA AWM I/II A/B

Multi core cable - 300 V

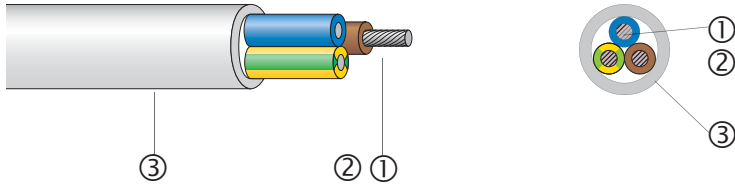

- Excellent high and low temperature and ozone resistance
- Weatherproof
- Easy to strip and process
- Flame retardant
- In case of fire no corrosive gases and low smoke emission
- Flexible

Application

Permanent installation indoor and outdoor for the connection of fixed and loose parts.

Composition of cable

① Cores:	
Conductor	stranded tin plated copper, acc. to EN 60228, class 5
Insulation	RADOX
Core colours	various, on request
② Fillers (optional)	RADOX
③ Sheath	RADOX 125M
Colour	grey

Technical data

Voltage rating		300 V AC
Test voltage		2000 V AC
Operating temperature	(UL temperature rating)	+125 °C
Max. conductor temperature	at short circuit (max. 5 s)	+280 °C
Min. operating temperature	flexing	-25 °C
	fixed	-40 °C
Min. bending radius		5 × cable-dia.

Standards

Appliance wiring material	CSA C22.2 no. 210.2	AWM I/II A/B 125 °C 300 V FT1
Appliance wiring material	UL 758	style 4486

RADOX® UL4486/CSA AWM I/II A/B

Multi core cable – 300 V

Fire tests

Flame propagation:

Vertical flame spread, single cable	CSA C22.2 no. 0.3 cl. 4.11.1	FT1
Horizontal flame propagation	CSA C22.2 no. 0.3 cl. 4.11.2	FT2
Vertical flame spread, single cable	EN 50265-2-1, IEC 60332-1	
Vertical flame spread, bunched cables	EN 50266-2-4, IEC 60332-3-24	category C

Flame propagation:

Horizontal flame propagation of an appliance wire	UL 1581 sec. 1090	
Vertical flame spread, single cable	UL 1581 sec. 1061	
Vertical flame spread, single cable	UL 1581 sec. 1080	VW-1

Approvals

CSA certificate	1241318
UL file	E63322

Extract from our delivery programme

Cross section	Conductor		Core		Cable
	nom. n x(G) AWG	Construction nom. n × mm dia.	R ₂₀ IEC 60228 max. Ω/km	Dia. nom. mm	Colours*
2 × 20	19 × 0.20	32.6	1.85	BU, BN	5.5 ± 0.3
2 × 18	19 × 0.25	21.3	2.10	BU, BN	6.0 ± 0.3
2 × 12	37 × 0.34	5.67	3.21	BU, BN	8.3 ± 0.3
4 × 14	19 × 0.37	9.02	2.72	BU, BN, BK, GY	8.5 ± 0.3

* Abbreviations for core colours see page 41.

Other cross sections on request.

RADOX® UL4486/CSA AWM I/II A/B

Multi core cable – screened – 300 V

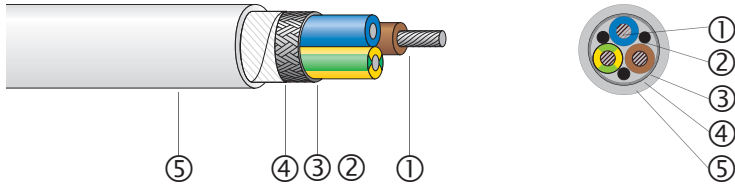

- Excellent high and low temperature and ozone resistance
- Weatherproof
- Easy to strip and process
- Flame retardant
- In case of fire no corrosive gases and low smoke emission
- Flexible

Application

Permanent installation indoor and outdoor for the connection of fixed and loose parts.

Composition of cable

① Cores:	
Conductor	stranded tin plated copper, acc. to EN 60228, class 5
Insulation	RADOX
Core colours	various, on request
② Fillers (optional)	RADOX
③ Screen	tin plated copper braid
④ Separator	plastic tape
⑤ Sheath	RADOX 125M
Colour	grey

Technical data

Voltage rating		300 V AC
Test voltage		2000 V AC
Operating temperature	UL temperature rating	+125 °C
Max. conductor temperature	at short circuit (max. 5 s)	+280 °C
Min. operating temperature	flexing	-25 °C
	fixed	-40 °C
Min. bending radius		5 × cable-dia.

Standards

Appliance wiring material	CSA C22.2 no. 210.2	AWM I/II A/B 125 °C 300 V FT1
Appliance wiring material	UL 758	style 4486

RADOX® UL4486/CSA AWM I/II A/B

Multi core cable – screened – 300 V

Fire tests

Flame propagation:

Vertical flame spread, single cable	CSA C22.2 no. 0.3 cl. 4.11.1	FT1
Horizontal flame spread, single cable	CSA C22.2 no. 0.3 cl. 4.11.2	FT2
Vertical flame spread, single cable	EN 50265-2-1, IEC 60332-1	
Vertical flame spread, bunched cables	EN 50266-2-4, IEC 60332-3-24	category C

Flame propagation:

Horizontal flame propagation of an appliance wire	UL 1581 sec. 1090	
Vertical flame spread, single cable	UL 1581 sec. 1061	
Vertical flame spread, single cable	UL 1581 sec. 1080	VW-1

Approvals

CSA certificate	1241318
UL file	E63322

Extract from our delivery programme

Cross section	Conductor		Core		Screen	Cable
nom. n × (G) AWG	Construction nom. n × mm dia.	R ₂₀ IEC 60228 max. Ω/km	Dia. nom. mm	Colours*	Dia. nom. mm	Dia. nom. mm
2 × 18	19 × 0.25	21.3	2.10	BU, BN	4.6	6.6 ± 0.3
2 × 14	19 × 0.37	9.02	2.72	BU, BN	6.0	7.9 ± 0.3
3 G 20	19 × 0.20	32.6	1.85	BU, BN, GNYE	4.5	6.4 ± 0.3
3 × 14	19 × 0.37	9.02	2.72	BU, BN, BK	6.5	8.3 ± 0.3
4 G 18	19 × 0.25	21.3	2.10	BU, BN, BK, GNYE	5.7	7.6 ± 0.3
4 × 12	37 × 0.34	5.67	3.21	BU, BN, BK, GY	8.8	10.7 ± 0.4

* Abbreviations for core colours see page 41.

Other cross sections on request

RADOX® UL4486/CSA AWM I/II A/B

Multi core cable - 600 V

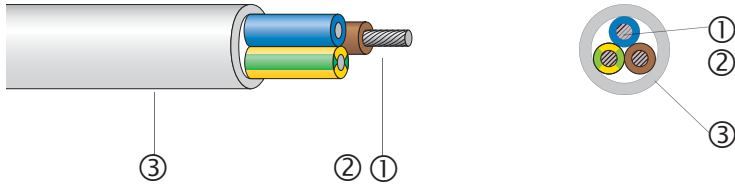

- Excellent high and low temperature and ozone resistance
- Weatherproof
- Easy to strip and process
- Flame retardant
- In case of fire no corrosive gases and low smoke emission
- Flexible

Application

Permanent installation indoor and outdoor for the connection of fixed and loose parts.

Composition of cable

① Cores:	
Conductor	stranded tin plated copper, acc. to EN 60228, class 5
Insulation	RADOX
Core colours	diverse, on request
② Fillers (optional)	RADOX
③ Sheath	RADOX 125M
Colour	grey

Technical data

Voltage rating		600 V AC
Test voltage		2500 V AC
Max. conductor temperature	in continuous operation	+125 °C
	10 000 h	+130 °C
	3000 h	+145 °C
	at short circuit (max. 5 s)	+ 280 °C
Min. operating temperature	flexing	-25 °C
	fixed	-40 °C
Min. bending radius		5 × cable-dia.

Standards

Appliance wiring material	CSA C22.2 no. 210.2	AWM I/II A/B 125 °C 600 V FT1
Appliance wiring material	UL 758	style 4486

RADOX® UL4486/CSA AWM I/II A/B

Multi core cable – 600 V

Fire tests

Flame propagation:

Vertical flame spread, single cable	CSA C22.2 no. 0.3 cl. 4.11.1	FT1
Horizontal flame spread, single cable	CSA C22.2 no. 0.3 cl. 4.11.2	FT2
Vertical flame spread, single cable	EN 50265-2-1, IEC 60332-1	
Vertical flame spread, bunched cables	EN 50266-2-4, IEC 60332-3-24	category C

Flame propagation:

Horizontal flame propagation of an appliance wire	UL 1581 sec. 1090	
Vertical flame spread, single cable	UL 1581 sec. 1061	
Vertical flame spread, single cable	UL 1581 sec. 1080	VW-1

Approvals

CSA certificate	1241318
UL file	E63322

Extract from our delivery programme

Cross section	Conductor		Core		Cable
	nom. n × (G) AWG	Construction nom. n × mm dia.	R ₂₀ IEC 60228 max. Ω/km	Dia. nom. mm	Colours*
1 × 1	378 × 0.40	0.385	13.7	BK	16.5 ± 0.3
2 × 20	19 × 0.20	32.6	2.60	BU, BN	7.0 ± 0.3
3 G 20	19 × 0.20	32.6	2.60	BU, BN, GNYE	7.45 ± 0.3
3 × 14	19 × 0.37	9.02	3.50	BU, BN, BK	9.4 ± 0.3
4 G 12	37 × 0.34	5.67	4.00	BU, BN, BK, GNYE	11.7 ± 0.4

* Abbreviations for core colours see page 41.

Other cross sections on request.

RADOX® UL 4486/CSA AWM I/II A/B

Multi core cable – screened – 600 V

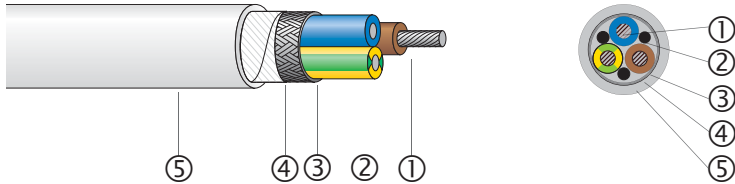

- Excellent high and low temperature and ozone resistance
- Weatherproof
- Easy to strip and process
- Flame retardant
- In case of fire no corrosive gases and low smoke emission
- Flexible

Application

Permanent installation indoor and outdoor for the connection of fixed and loose parts.

Composition of cable

① Cores:	
Conductor	stranded tin plated copper, acc. to EN 60228, class 5
Insulation	RADOX
Core colours	various, on request
② Fillers (optional)	RADOX
③ Screen	tin plated copper braid
④ Separator	plastic tape
⑤ Sheath	RADOX 125M
Colour	grey

Technical data

Voltage rating		600 V AC
Test voltage		2500 V AC
Operating temperature	(UL temperature rating)	+125 °C
Max. conductor temperature	at short circuit (max. 5 s)	+280 °C
Min. operating temperature	flexing	-25 °C
	fixed	-40 °C
Min. bending radius		5 × cable-dia.

Standards

Appliance wiring material	CSA C22.2 no. 210.2	AWM I/II A/B 125 °C 600 V FT1
Appliance wiring material	UL 758	style 4486

RADOX® UL 4486/CSA AWM I/II A/B

Multi core cable – screened – 600 V

Fire tests

Flame propagation:

Vertical flame spread, single cable	CSA C22.2 no. 0.3 cl. 4.11.1	FT1
Horizontal flame spread, single cable	CSA C22.2 no. 0.3 cl. 4.11.2	FT2
Vertical flame spread, single cable	EN 50265-2-1, IEC 60332-1	
Vertical flame spread, bunched cables	EN 50266-2-4, IEC 60332-3-24	category C

Flame propagation:

Horizontal flame propagation of an appliance wire	UL 1581 sec. 1090	
Vertical flame spread, single cable	UL 1581 sec. 1061	
Vertical flame spread, single cable	UL 1581 sec. 1080	VW-1

Approvals

CSA certificate	1241318
UL file	E63322

Extract from our delivery programme

Cross section nom. n × (G) AWG	Conductor		Core		Screen	Cable
	Construct. nom. n × mm dia.	R ₂₀ IEC 60228 max. Ω/km	Dia. nom. mm	Colours*	Dia. nom. mm	Dia. mm
1 G 2*	266 × 0.40	0.554	11.1	GNYE	12.2	14.1 ± 0.3
1 × 3/0	444 × 0.50	0.206	17.3	BK	18.4	22.8 ± 0.3
2 × 14	19 × 0.37	9.02	3.50	BU, BN	7.7	9.6 ± 0.3
3 G 20	19 × 0.20	32.6	2.60	BU, BN, GNYE	6.2	8.1 ± 0.3
3 × 8	80 × 0.40	1.96	6.40	BK, YE num.	15.1	18.2 ± 0.5
4 × 22	19 × 0.16	54.7	2.4	WH num.	6.6	8.5 ± 0.3
4 G 16	19 × 0.31	13.7	3.10	BU, BN, BK, GNYE	8.7	10.7 ± 0.4
4 × 6	119 × 0.40	1.25	8.60	BU, BN, BK, GY	22.5	27.3 ± 0.6
5 × 18	19 × 0.25	21.3	2.85	BU, BN, BK, GY, BK	8.7	10.7 ± 0.4
12 G 14	19 × 0.37	9.02	3.50	BK, YE num., GNYE	15.7	18.8 ± 0.5

* Abbreviations for core colours see page 41.

Other cross sections on request.

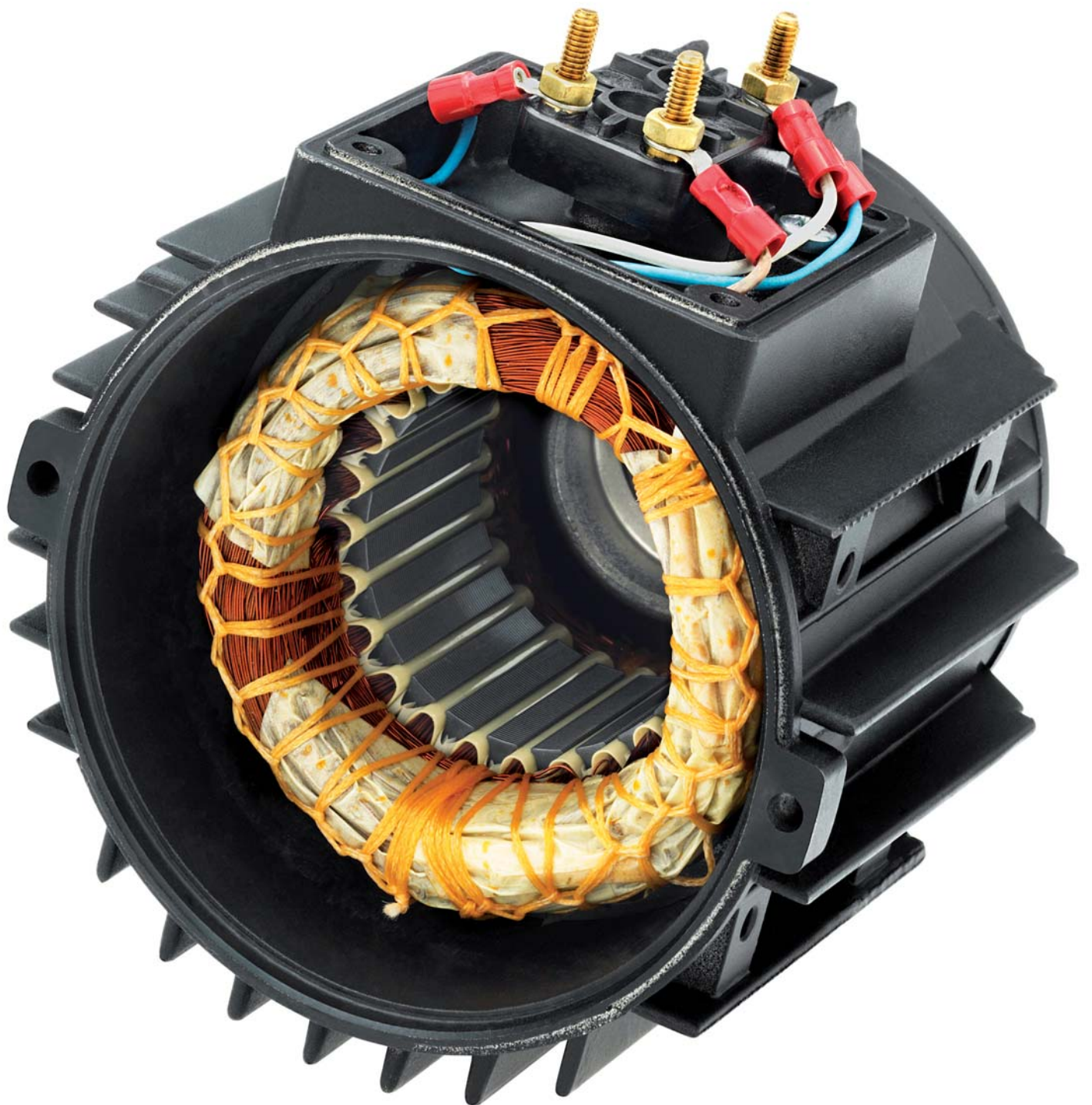

Technical Information

Delivery spools	38
Conversion AWG	40
Thermal classes	40
Colour table	41
Material designations	41
Resistance to cold and heat	42
Core colours	43
Characteristics of materials	44
Fire test methods	46
Current carrying capacity	49

Delivery spools

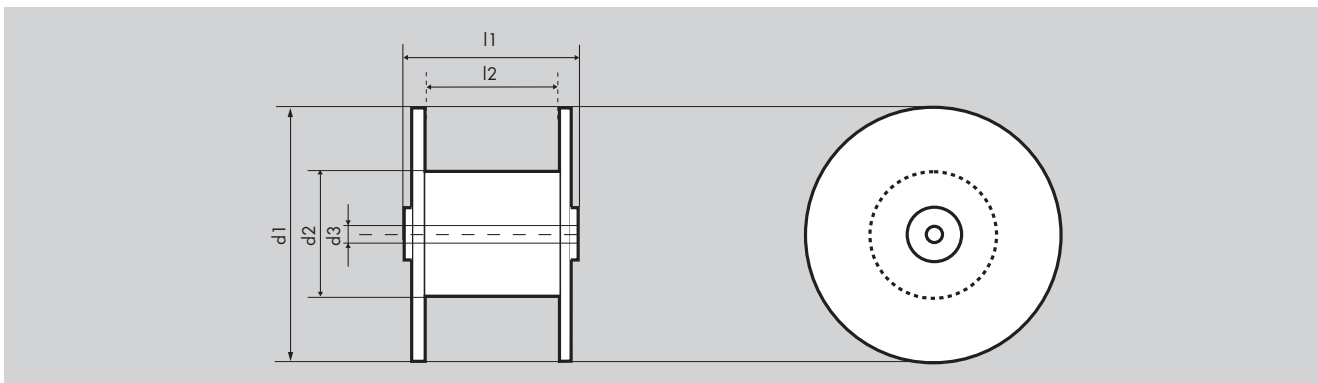





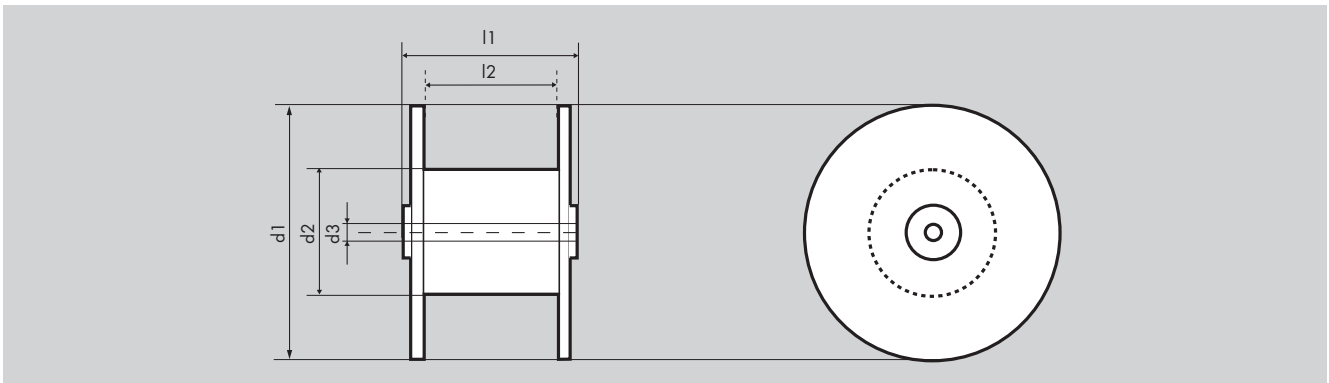

	Plastic reel Nr. 7	Plastic reel DIN 250	Plastic reel L355	Plywood reel L450/13	Plywood reel L450/14	Plywood reel L500
						
d 1	170	250	355	450	450	500
d 2	65	160	200	200	312	250
d 3	60	22	36	50	50	50
l 1	135	200	160	244	244	321
l 2	130	160	150	228	228	305
Tara kg	0.15	0.71	1.54	2.48	3.02	3.16

Cable Ø mm	Cable length per delivery m					
1	2020	3710	8100			
2	500	930	2030	5820		
4	130	230	510	1450	940	2240
6		100	220	650	420	1000
8			130	360	230	560
10				230	150	360
12				160	100	250
14				120	80	180
16						140
18						110
20						
22						
24						

- d1 flange diameter (mm)
- d2 core diameter (mm)
- d3 drill hole diameter (mm)
- l1 external width (mm)
- l2 reel width (mm)

Delivery spools



	Plywood reel LHL710	Wooden reel LHL900	Wooden reel LHL1050	Reusable NPS coil 250 × 400 (CK2)	Reusable NPS coil 400 × 400 (CK4)
					
d 1	710	900	1050	400	400
d 2	360	450	550	208 - 260	176 - 260
d 3	82	82	82	80	80
l 1	430	545	698	313	463
l 2	400	450	600	250	400
Tara kg	10	36	53	2.4	2.7

Cable Ø mm	Cable length per delivery m			For details about length, instruction manual and accessories ask for separate documentation.
1				
2				
4	5880			
6	2610	4770	8380	
8	1470	2680	4710	
10	940	1720	3010	
12	650	1190	2090	
14	480	880	1540	
16	370	670	1180	
18	290	530	930	
20	230	430	750	
22		350	620	
24		300	520	

Conversion AWG

Metric wire cross sections and wire diameters

AWG = American Wire Gauge

AWG	with UL/CSA		with MIL
	Cross section mm ² nom.	Diameter mm nom.	Cross section mm ² nom.
36	0.013	0.13	-
34	0.020	0.16	-
32	0.032	0.20	-
30	0.051	0.25	0.057
28	0.081	0.32	0.090
26	0.13	0.40	0.15
24	0.21	0.51	0.24
22	0.32	0.64	0.38
20	0.52	0.81	0.62
18	0.82	1.0	0.96
16	1.3	1.3	1.2
14	2.1	1.6	1.9
12	3.3	2.1	3.0
10	5.3	2.6	4.7
8	8.4	3.3	8.6
6	13	4.1	14
4	21	5.2	22
3	27	5.8	-
2	34	6.5	34
1	42	7.3	41
1/0	54	8.3	53
2/0	67	9.3	67
3/0	85	10	84
4/0	107	12	107

Thermal classes of insulating materials acc. to EN 60085

Thermal class	Max. limiting temperature	Thermal class	Max. limiting temperature	Thermal class	Max. limiting temperature
Y	90 °C	B	130 °C	200	200 °C
A	105 °C	F	155 °C	220	220 °C
E	120 °C	H	180 °C	250	250 °C

Colour table

- BK = black/schwarz
- TQ = turquoise/türkis
- WH = white/weiss
- BN = brown/braun
- BU = blue/blau
- RD = red/rot
- YE = yellow/gelb
- GN = green/grün
- GY = grey/grau
- OG = orange/orange
- VT = violet/violett
- PK = pink/rosa
- GNYE = green-yellow/grün-gelb

Material designations

Thermoplastics

ETFE
FEP
LSFH™

PBT FR
PE
PTFE
PVC
TPE-E
TPU

Ethylene-tetrafluoroethylene copolymer
Tetrafluoroethylene-perfluoropropylene copolymer
Halogen free, flame retardant material
(low smoke free of halogen)
Flame retardant polybutylene terephthalate
Polyethylene
Polytetrafluoroethylene
Polyvinylchloride
Thermoplastic polyester elastomers
Thermoplastic polyurethane

Crosslinked materials

CR Chloroprene rubber
EPR
PE-X
PVDF-X
RADOX® 125
RADOX® 125A
RADOX® 125M
RADOX® 125TM
RADOX® 155
RADOX® 155S
RADOX® ELASTOMER S (REMS)
RADOX® ELASTOMER S FH (REMS FH)
SIR
ETFE-X

Ethylene propylene rubber
Crosslinked polyethylene
Crosslinked polyvinylidene fluoride
Polyolefin copolymer
Polyolefin copolymer
Polyolefin copolymer
Ethylene acrylate copolymer
Polyolefin copolymer
Polyolefin copolymer
Ethylene acrylate copolymer
Ethylene acrylate copolymer
Silicon rubber
Crosslinked Ethylene tetrafluoroethylene

RADOX® is a registered trademark of HUBER+SUHNER for electron beam crosslinked, heat resistant cable insulations and sheaths.

LSFH™ is a registered trademark of HUBER+SUHNER for halogen free, flame retardant cable sheaths.

Resistance to cold and heat

Typical operating temperature ranges of different insulations and sheaths

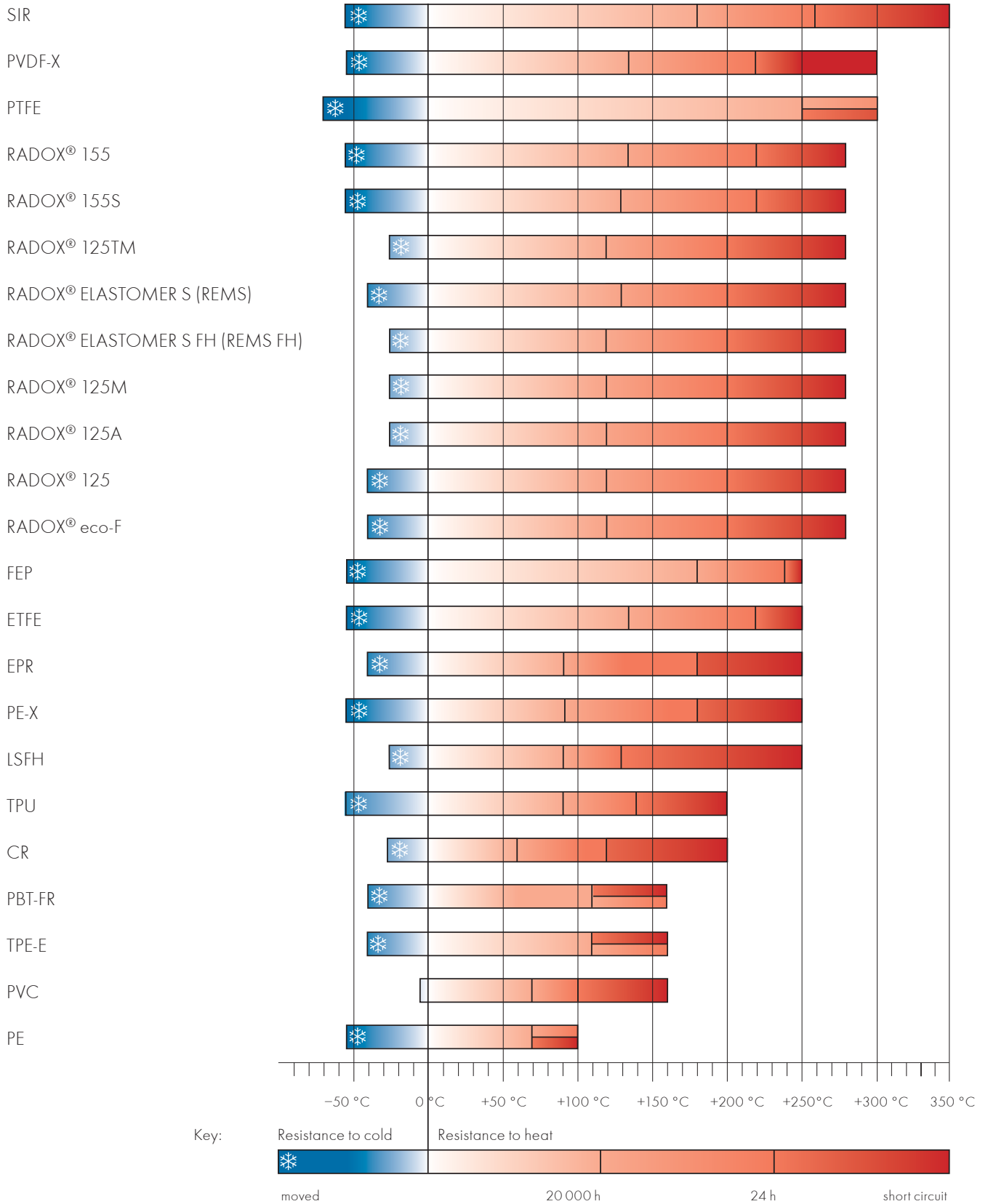

Core colours VDE 0293-308/HD 308 S2 vs. HD 308













Example













Core numbers:

New
HD 308 S2

Old
HD 308















with yellow-green grounding wire















3					
4					
5					

3					
4					
5					

Old
SEV 1101, 1102

without yellow-green grounding wire

2					
3					
4					
5					

2					
3					
4					
5					

black



brown



blue



grey



yellow-green



Characteristics of materials

Typical characteristics of various insulation and jacket materials for cables

Abbreviations ⁽¹⁾	Insulation compounds													
	Thermoplastics							Crosslinked materials						
	PVC	PE	PBT-FR	TPE-E	ETFE	FEP	PTFE	EPR	PE-X	RX 125	RX 155S	RX 155	PVDF-X	SIR
CENELEC type	TII							EI6						
Thermal characteristics														
Thermal resistance														
20 000 h (°C)	70	70	110	110	135	180	250	90	90	120	130	135	135	180
24 h (°C)	100	100	160	160	220	240	300	180	180	200	220	220	220	260
Short circuit (°C)	160	100	160	160	250	250	300	250	250	250	250	250	300	350
Resistance to cold, moved (°C)	-5	-55	-40	-40	-55	-55	-70	-40	-55	-40	-55	-55	-55	-55
Mechanical characteristics														
Tensile strength (N/mm ²)	≥12.5	≥10	≥25	≥30	≥30	≥10	≥20	≥5.0	≥12.5	≥12.5	≥12.5	≥15	≥28	≥5.0
Elongation at break (%)	≥125	≥300	≥200	≥200	≥150	≥200	≥200	≥200	≥200	≥200	≥200	≥300	≥200	≥150
Abrasion resistance	satisf.	good	good	very good	very good	satisf.	satisf.	satisf.	very good	good	very good	good	very good	poor
Flexibility ⁽²⁾	satisf.	poor	poor	poor	poor	poor	poor	very good	poor	satisf.	poor	satisf.	poor	very good
Electrical characteristics														
Volume resistivity at 20 °C (Ωcm)	1014	1016	1015	1015	1016	1018	1018	1015	1016	1014	1016	1016	1014	1015
Dielectric constant at 1 kHz	5.0	2.3	3.7	3.8	2.6	2.2	2.0	3.0	2.4	4.2	2.6	2.8	5.7	3.0
Fire characteristics														
Flame retardant	yes	no	yes	no	yes	yes	yes	no	no	yes	yes	yes	yes	ja
Halogen free	no	yes	yes	yes	no	no	no	yes	yes	yes	no	no	no	ja
Corrosive combustion gases	yes	no	no	no	yes	yes	yes	no	no	no	yes	yes	yes	no
Smoke generation	strong	average	average	average	low	low	low	average	average	low	strong	strong	low	average
Resistance to														
Ionizing radiation (kGy)	100	1000	1000	1000	2000	100	1	2000	1000	1000	1000	1000	1000	500
Solvents ⁽³⁾	satisf.	satisf.	good	good	very good	very good	very good	satisf.	satisf.	satisf.	good	satisf.	very good	satisf.
Oils and fuels ⁽³⁾	satisf.	satisf.	good	good	very good	very good	very good	poor	satisf.	satisf.	good	satisf.	very good	satisf.
Acids and alkaline solutions ⁽³⁾	good	very good	satisf.	satisf.	very good	very good	very good	very good	very good	good	good	good	very good	satisf.
Water/hydrolysis ⁽³⁾	good	very good	satisf.	satisf.	very good	very good	very good	good	very good	good	very good	very good	very good	very good
Weather/UV radiation	good	poor	good	good	very good	very good	very good	good	satisf.	good	good	good	very good	very good

(1) RX = RADOX®, for other abbreviations see following page «Material designations»

(2) Depends greatly on cable construction

(3) Influenced by type, time and medium temperature

Important:

As the characteristics of compounds may vary widely according to their specific formulation, the values stated in the table must be understood as approximate values referring to typical representatives of their material class.

The data is based on laboratory investigations and practical experience. It is stated to the best of our knowledge, but without guarantee. We will gladly advise you in individual cases.

Characteristics of materials

Typical characteristics for cables

Abbreviation ⁽¹⁾ CENELEC type	Sheat compounds							
	Thermoplastics		Crosslinked materials					
	LSFH	TPU	CR	RX 125A	RX 125M	RX 125TM	REMS	REMS FH
	TMPU	EM2						
Thermal characteristics								
Thermal resistance								
20 000 h (°C)	90	90	60	120	120	120	130	120
24 h (°C)	130	140	120	200	200	200	200	200
Short circuit (°C)	250	200	200	280	280	280	280	280
Resistance to cold, moved (°C)	-25	-55	-25	-25	-25	-25	-40	-25
Mechanical characteristics								
Tensile strenght (N/mm ²)	≥ 9,0	≥ 25	≥ 10	≥ 10	≥ 9	≥ 10	≥ 15	≥ 10
Elongation at break (%)	≥ 125	≥ 300	≥ 300	≥ 125	≥ 125	≥ 125	≥ 300	≥ 125
Abrasion resistance	good	very good	good	good	good	good	good	good
Flexibility ⁽²⁾	satisf.	satisf.	very good	satisf.	good	good	good	good
Electrical characteristics								
Volume resistivity at 20 °C (Ωcm)	10 ¹³	10 ¹²	10 ¹⁰	10 ¹⁴	10 ¹²	10 ¹²	10 ¹²	10 ¹²
Dielectric constant at 1 kHz	5	7	8	4.8	6	5	4.8	5.5
Fire characteristics								
Flame retardant	yes	no	yes	yes	yes	yes	yes	yes
Halogen free	yes	yes	no	yes	yes	yes	no	yes
Corrosive combustion gases	no	no	yes	no	no	no	yes	no
Smoke generation	low	average	stark	low	low	low	stark	low
Resistance to								
Ionizing radiation (kGy)	1000	5000	500	1000	1000	1000	1000	1000
Solvents ⁽³⁾	poor	satisf.	satisf.	satisf.	satisf.	satisf.	satisf.	satisf.
Oils and fuels ⁽³⁾	poor	good	good	satisf.	good	good	very good	very good
Acids and alkaline solutions ⁽³⁾	satisf.	satisf.	very good	good	good	very good	very good	good
Water/hydrolysis ⁽³⁾	satisf.	very good	good	good	good	very good	good	good
Weather/UV radiation	satisf.	good	good	good	good	good	very good	good

(1) RX = RADOX®, for other abbreviations see following page «Material designations»

(2) Depends greatly on cable construction

(3) Influenced by type, time and medium temperature

Important:

As the characteristics of compounds may vary widely according to their specific formulation, the values stated in the table must be understood as approximate values referring to typical representatives of their material class.

The data is based on laboratory investigations and practical experience. It is stated to the best of our knowledge, but without guarantee. We will gladly advise you in individual cases.

Fire test methods

Fire test methods for electrical wires and cables

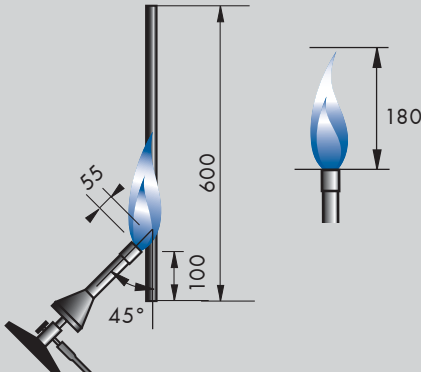
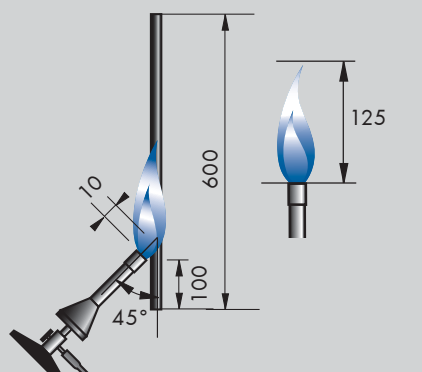
Designation	EN 50265-2-1 IEC 60332-1	EN 50265-2-2 IEC 60332-2
Flame temperature	Determined by the prescribed adjustment of the flame.	Determined by the prescribed adjustment of the flame.
Test duration	cable dia $D \leq 25$ mm: 60 s cable dia $25 < D \leq 50$ mm: 120 s	20 s
Conditions	The cable shall be self extinguishing. The damage by fire shall be more than 50 mm from the top fastening clamp.	The cable shall be self extinguishing. The damage by fire shall be more than 50 mm from the top fastening clamp.
		

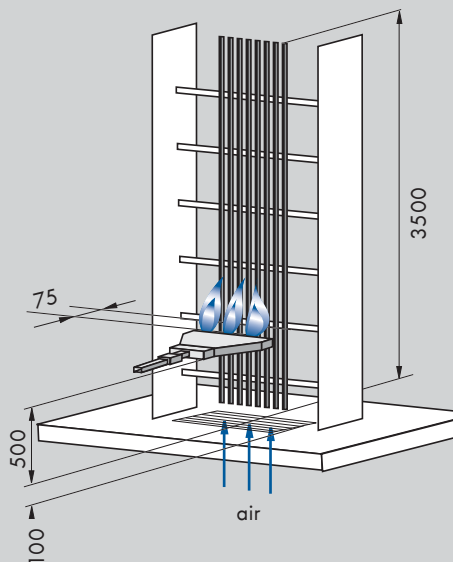
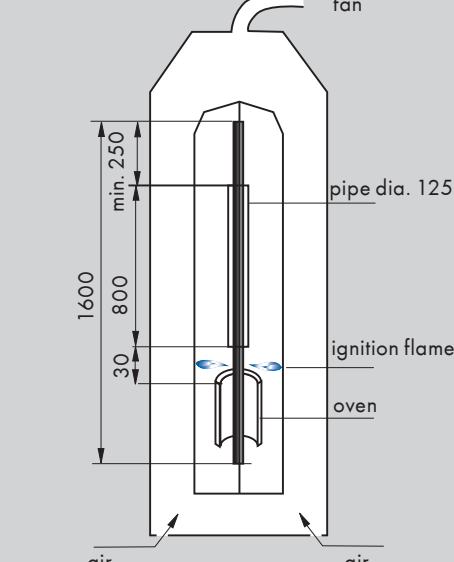
Designation	EN 50266-2-4 IEC 60332-3-24	NF C32-070 test 2 UIC 895 VE appendix 7
Flame temperature	Determined by the prescribed propane gas and air volumes.	830 ± 50 °C
Test duration	cat. A (7 l combustible material): 40 min. cat. B (3.5 l combustible material): 40 min. cat. C (1.5 l combustible material): 20 min.	30 min.
Conditions	The damage by fire shall be maximum 2.5 m from the lower burner end.	The cable piece projecting from the pipe shall be not damaged.
		

Fire test methods

Fire test methods for electrical wires and cables

Designation	MIL-W-22759 and MIL-W-81044 VG 95218-2 procedure 4	VG 95218-2 procedure 3
Flame temperature	min. 950 °C	Determined by the prescribed adjustment of the flame.
Test duration	30 s	cable dia $D \leq 25$ mm: 60 s cable dia $25 < D \leq 50$ mm: 120 s
Conditions	The specimen shall not continue to burn for more than 30 s, and damage by fire shall not exceed 76 mm. Dripping material shall not ignite the tensioned tissue paper (S).	The specimen shall not continue to burn for more than 30 s, and damage by fire shall not exceed 76 mm. Dripping material shall not ignite the tensioned tissue paper (S).

Designation	UL 1581 section 1090 Horizontal specimen AWM flame test	UL 1581 section 1061 UL 1581 section 1080 (VW1)
Flame temperature	Determined by the prescribed adjustment of the flame.	Determined by the prescribed adjustment of the flame.
Test duration	30 s	sect.1061: 60 s flaming, 30 s pause (3 x) sect.1080: 15 s flaming, 15 s pause (5 x)
Conditions	The rate of the flame propagation shall not exceed 25 mm/min. Dripping material shall not ignite the cotton wool underneath (B).	The paper shall not be burned more than 25 %, and the specimen shall not continue to burn for more than 60 s. Dripping material shall not ignite the cotton wool underneath (B).

Fire test methods

Fire test methods for electrical wires and cables

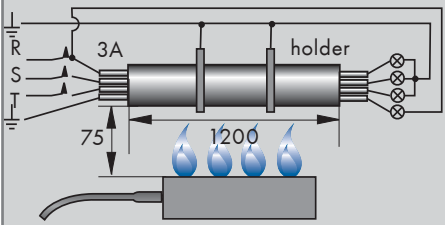
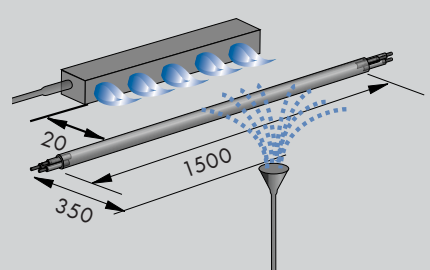
Designation	IEC 60331-21, IEC 60331-23 DIN VDE 0472-814 BS 6387, category C	BS 6387, category W
Flame temperature	IEC, DIN VDE: min. 750 °C BS : 950 ± 40 °C.	650 ± 40 °C
Test duration	IEC: 90 min. recommended DIN VDE, BS: 180 min.	30 min.
Conditions	Zwischen den Adern wird eine Prüfspannung angelegt. IEC: power cable: U_0/U IEC, DIN VDE: data cable: 110 V DIN VDE: power cable: 230/400 V BS: all U_0/U The fuses shall not blow and the incandescent lamps shall not extinguish.	A test voltage is applied between the cores which equals the mains voltage U_0/U . After 15 min. exposure to the flame, the sprinkler is additionally switched on. The fuses shall not blow and the incandescent lamps shall not extinguish.
		

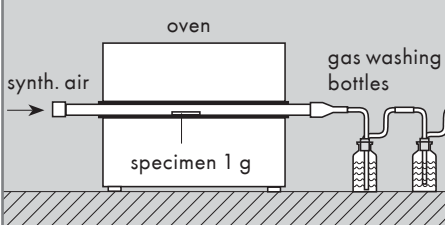
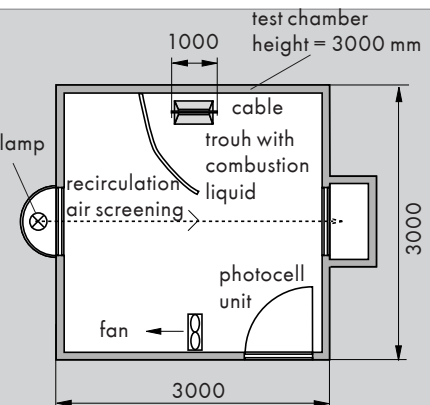
Designation	EN 50267-2-2 IEC 60754-2	EN 50268-2 IEC 61034-2
Flame temperature	min. 935 °C	Determined by the composition of the combustion liquid.
Test duration	30 min.	40 min.
Conditions	The pH value of the washing water shall be min. 4.3, its conductivity shall not exceed 10 µS/mm.	The light permeability of the resulting smoke shall be min. 60 %.
		

Current carrying capacity

of RADOX® 125 single core and multi core cables

Scope

The following tables referring to RADOX connecting leads and multicore cables give easy and fast support for the layout of apparatus and components.

The following remarks are based on today's state of the art and practical experience as described in the standard IEC 60216, IEC 60287 and IEC 60364. The application of products will frequently vary from the theoretical values of constant ambient temperature, constant current carrying, homogeneous laying and others. That means, in practice the theoretical current carrying will differ from the real values.

For a safe layout of apparatus and components it is recommended to carry out a test with the installed connecting lead or cable under service conditions.

Definitions

Current load	current passed through the cable during operation
Continuous operation	an operation with constant current whose duration is at least long enough to allow the system to reach thermal equilibrium, but may then go on indefinitely
Current rating	maximum permissible current under determined operating
Permissible operating temperature	maximum permissible temperature on the conductor in continuous operation
Wire	insulated single core
Cable	bundle with jacket with one ore more insulated single cores
Conductor temperature	temperature of the surface of the core material

General remarks

The current rating of a cable depends on the conductor cross section, on the cable design, on the characteristics of the insulation materials, on the installation conditions and, for larger cross sections, on the frequency (skin and proximity effects). Also, additional heating effects due to higher ambient temperatures, due to heating elements and due to bunching of cables have to be taken into account.

The conductor cross section has to be selected in such a way that the actual current load does not exceed the curent rating, i. e. the conductor temperature does not exceed the permissible operating temperature. The determining factor is the appropriate, most unfavourable operating condition, encountered during operation over the whole length of the cable.

Current rating under service conditions I in A

$$I = I_N \cdot f_1 \cdot f_2 \cdot f_3 \cdot f_4 \cdot f_5$$

I [A]	Current rating for continuous operation under service conditions
I_N [A]	Current rating for continuous operation under standard conditions
f_1	Reduction factor for increased ambient temperature
f_2	Conversion factor for deviated conductor temperature, acc. to temperature index, IEC 60216 (20 000 h)
f_3	Reduction factor for multicore cables
f_4	Reduction factor for increased frequency
f_5	Reduction factor for bundeled cables

Current carrying capacity

of RADOX® single core and multi core cables

Standard conditions for current rating I_N in A

The tabled values for the current rating were calculated according to IEC 60287 for the following standard conditions:

- Continuous operation
- Single circuit for 3-phase current, single conductor for 1-phase current
- 30 °C ambient temperature and sufficiently large and ventilated spaces, whose ambient temperature is not appreciably increased by the heat coming from the cables.
- 120 °C conductor temperature
- Frequency up to 200 Hz

Installation in air, unrestricted heat dissipation, means that the following installation conditions are observed:

- Distance of the cables from the wall, from the floor, from the ceiling > cable diameter
- Distance between two adjacent power circuits > 2 × cable diameter
- Vertical distance between power circuits laid one upon another for individual cables > 2 × cable diameter and for layers of cables > 200 mm
- Perforated tray with a perforation > 30 % of the total surface

Open trays are continuous supports with vertical sides, but without cover. A possible perforation accounts for < 30 % of the total surface.

Closed ducts are entirely closed. Pipes belong to this category also. The max. filling degree is 60 %.

Maximum permitted conductor temperature for various insulating materials according to IEC 60216 (20 000 h/50 % elongation at break):

PVC, CR	70 °C
PE-X, EPR	90 °C
RADOX 125	120 °C
RADOX 155	135 °C

Life time expectation

If crosslinked wires are used at higher temperatures than indicated by the temperature index of IEC 60216, the life time is reduced accordingly. Analogical, the life time will increase at lower temperature. RADOX® 125 for example has a life span of 20 000 h at a conductor temperature of +120 °C, which is approx. 2.5 years. If it is used at another temperature, life time expectations are as follows:

Example RADOX 125, that is 120 °C/20 000 h

160 °C	1 250 h
150 °C	2 500 h
140 °C	5 000 h
130 °C	10 000 h
120 °C	20 000 h
110 °C	40 000 h
100 °C	80 000 h
90 °C	160 000 h
80 °C	320 000 h

Current carrying capacity

of RADOX® single core and multi core cables

Reduction factors for increased ambient temperature f_1

Ambient temp. °C	30	35	40	45	50	55	60	65	70	75	80	85	90	95	100	105	110	115
Reduction factor f_1	1	0.97	0.94	0.91	0.88	0.85	0.82	0.78	0.75	0.71	0.67	0.62	0.58	0.53	0.47	0.41	0.33	0.22

Reduction factors for different permissible conductor temperature f_2

Conductor temp. °C	135	120	110	100	90	80
Reduction factor f_2	1.04	1	0.96	0.91	0.85	0.79

Reduction factors for multicore cables f_3

No. of cores in cable	3	4	5	7	8	10	14	16	19	20	24	27	33	40	61
Reduction factor f_3	1.0	0.80	0.75	0.65	0.62	0.55	0.50	0.48	0.45	0.44	0.40	0.39	0.37	0.35	0.30

Reduction factors for increased frequency f_4

Frequency Hz*	400	600	800	1000	2000	3000	4000	5000	10000
Copper conductor cross section mm ²	faktors f_4								
1.5	1	1	1	1	1	1	1	1	1
2.5	1	1	1	1	1	1	1	1	1
4	1	1	1	1	1	1	1	1	0.98
6	1	1	1	1	1	1	1	0.99	0.93
10	1	1	1	1	1	1	0.96	0.93	0.82
16	1	1	1	1	1	0.95	0.91	0.87	0.76
25	1	1	1	1	0.94	0.88	0.83	0.80	0.69
35	1	1	1	0.98	0.89	0.82	0.77	0.74	0.64
50	1	1	0.97	0.94	0.83	0.76	0.72	0.69	0.59
70	1	0.95	0.91	0.88	0.77	0.71	0.67	0.63	0.54
95	0.98	0.93	0.88	0.84	0.73	0.67	0.63	0.60	0.51
120	0.94	0.88	0.84	0.80	0.69	0.64	0.60	0.57	0.48
150	0.90	0.85	0.80	0.77	0.66	0.61	0.57	0.54	0.46
185	0.88	0.82	0.77	0.74	0.64	0.58	0.54	0.52	0.44
240	0.85	0.77	0.72	0.69	0.60	0.54	0.51	0.48	0.41
300	0.79	0.73	0.69	0.66	0.57	0.52	0.48	0.46	0.39
400	0.75	0.69	0.65	0.63	0.54	0.49	0.46	0.44	0.37

* We recommend that you use a special conductor design for frequencies > 800 Hz and cross sections > 25 mm² (waveguide design).

Current carrying capacity

of RADOX® single cores

Installation method	Connecting lead in free air or perforated tray										
Number of simultaneous loaded conductors on each tray											
	1	2	3	4	6	8	10	16	20	4	6
Reduction factor f_s	1	0.87	0.81	0.78	0.75	0.74	0.73	0.72	0.71	0.71	0.62
Copper conductor cross section mm^2	Current carrying capacity A										
0.50	19	16.4	15.3	14.7	14.2	14.0	13.8	13.6	13.4	13.4	11.7
0.75	24	20.8	19.4	18.6	17.9	17.7	17.4	17.2	17.0	17.0	14.8
1.0	29	24.8	23.1	22.2	21.4	21.1	20.8	20.5	20.2	20.2	17.7
1.5	36	31	29	28	27	26	26	26	25	25	22
2.5	49	43	40	38	37	36	36	35	35	35	30
4	66	57	53	51	49	49	48	47	47	47	41
6	85	74	69	67	64	63	62	61	61	61	53
10	121	105	98	94	91	90	88	87	86	86	75
16	163	142	132	127	122	121	119	117	116	116	101
25	219	191	177	171	164	162	160	158	155	155	136
35	272	237	220	212	204	201	199	196	193	193	169
50	344	299	279	268	258	255	251	248	244	244	213
70	439	382	356	342	329	325	320	316	312	312	272
95	523	455	424	408	392	387	382	377	371	371	324
120	621	540	503	484	466	460	453	447	441	441	385
150	723	629	586	564	542	535	528	521	513	513	448
185	825	718	668	644	619	611	602	594	586	586	512
240	996	867	807	777	747	737	727	717	707	707	618
300	1150	1001	932	897	863	851	840	828	817	817	713
400	1473	1282	1194	1149	1105	1091	1076	1061	1046	1046	914

Continuous current rating

conductor temperature 120 °C, ambient temperature 30 °C



8	10	16	20	4	6	8	10	16	20	4	6	8	10	16	20
0.57	0.53	0.47	0.45	0.67	0.59	0.54	0.50	0.45	0.43	0.71	0.58	0.52	0.48	0.41	0.38

10.8	10.0	8.9	8.5	12.7	11.2	10.2	9.5	8.5	8.1	13.4	11.0	9.8	9.1	7.7	7.2
13.6	12.7	11.2	10.8	16.0	14.1	12.9	12.0	10.8	10.3	17.0	13.9	12.4	11.5	9.8	9.1
16.2	15.1	13.4	12.8	19.1	16.8	15.4	14.3	12.8	12.3	20.2	16.5	14.8	13.7	11.7	10.8
20	19	17	16	24	21	19	18	16	15	25	21	19	17	15	14
28	26	23	22	33	29	26	24	22	21	35	28	25	23	20	19
38	35	31	30	44	39	36	33	30	28	47	38	34	32	27	25
49	45	40	38	57	50	46	43	38	37	61	49	44	41	35	32
69	64	57	54	81	71	65	61	54	52	86	70	63	58	50	46
93	86	77	73	109	96	88	82	73	70	116	95	85	78	67	62
125	116	103	99	147	129	118	110	99	94	155	127	114	105	90	83
155	144	128	122	182	160	147	136	122	117	193	158	141	131	112	103
196	182	162	155	230	203	186	172	155	148	244	200	179	165	141	131
250	233	206	198	294	259	237	220	198	189	312	255	228	211	180	167
298	277	246	235	350	309	282	262	235	225	371	303	272	251	214	199
354	329	292	279	416	366	335	311	279	267	441	360	323	298	255	236
412	383	340	325	484	427	390	362	325	311	513	419	376	347	296	275
470	437	388	371	553	487	446	413	371	355	586	479	429	396	338	314
568	528	468	448	667	588	538	498	448	428	707	578	518	478	408	378
656	610	541	518	771	679	621	575	518	495	817	667	598	552	472	437
840	781	693	663	987	870	796	737	663	634	1046	855	766	708	604	560

Current carrying capacity

of RADOX® single cores

Installation method	on floor or wall				fixed on a ceiling or under floor							
Number of simultaneous loaded conductors on each tray												
	1	2	3	4	1	2	3	4	5	6	7	8
Reduction factor f_s	1	0.87	0.79	0.75	0.95	0.81	0.72	0.68	0.66	0.64	0.63	0.62
Copper conductor cross section mm^2	Current carrying capacity in A											
0.50	18	15.3	14.2	13.5	17.1	14.5	12.9	12.2	11.9	11.5	11.3	11.1
0.75	23	19.3	17.9	17.0	21.6	18.4	16.3	15.4	15.0	14.5	14.3	14.1
1.0	27	23.0	21.4	20.3	25.7	21.9	19.5	18.4	17.9	17.3	17.1	16.8
1.5	34	29	27	25	32	27	24	23	22	22	21	21
2.5	46	39	37	35	44	38	33	32	31	30	29	29
4	63	53	49	47	59	51	45	43	41	40	39	39
6	81	69	64	61	77	66	58	55	53	52	51	50
10	115	98	91	86	109	93	83	78	76	74	72	71
16	155	132	122	116	147	125	111	105	102	99	98	96
25	208	177	164	156	198	169	150	141	137	133	131	129
35	258	220	204	194	245	209	186	176	171	165	163	160
50	327	278	258	245	310	265	235	222	216	209	206	203
70	417	354	329	313	396	338	300	284	275	267	263	259
95	497	422	393	373	472	402	358	338	328	318	313	308
120	590	501	466	442	560	478	425	401	389	378	372	366
150	687	584	543	515	653	556	495	467	453	440	433	426
185	784	666	619	588	745	635	564	533	517	502	494	486
240	946	804	747	710	899	766	681	643	624	606	596	587
300	1093	929	863	819	1038	885	787	743	721	699	688	677
400	1352	1150	1069	1114	1285	1096	974	920	893	866	852	839

Continuous current rating

conductor temperature 120 °C, ambient temperature 30 °C

in conduit, in a void or in a pipe

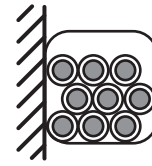
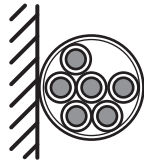

≥ 9	1	2	3	4	5	6	7	8	9	10	12	14	16	20
0.61	1	0.80	0.70	0.65	0.60	0.57	0.54	0.52	0.50	0.48	0.45	0.43	0.41	0.38

11.0	14.4	11.5	10.1	9.3	8.6	8.2	7.8	7.5	7.2	6.9	6.5	6.2	5.9	5.5
13.9	18.2	14.5	12.7	11.8	10.9	10.4	9.8	9.4	9.1	8.7	8.2	7.8	7.4	6.9
16.5	22	17.3	15.2	14.1	13.0	12.3	11.7	11.3	10.8	10.4	9.7	9.3	8.9	8.2
21	27	22	19	18	16	15	15	14	14	13	12	12	11	10
28	37	30	26	24	22	21	20	19	19	18	17	16	15	14
38	50	40	35	33	30	29	27	26	25	24	23	22	21	19
49	65	52	45	42	39	37	35	34	32	31	29	28	27	25
70	92	74	64	60	55	52	50	48	46	44	41	40	38	35
94	124	99	87	81	74	71	67	64	62	59	56	53	51	47
127	166	133	117	108	100	95	90	87	83	80	75	72	68	63
158	207	165	145	134	124	118	112	107	103	99	93	89	85	79
199	261	209	183	170	157	149	141	136	131	125	118	112	107	99
254	334	267	234	217	200	190	180	173	167	160	150	143	137	127
303	397	318	278	258	238	227	215	207	199	191	179	171	163	151
360	472	378	330	307	283	269	255	245	236	227	212	203	194	179
419	549	440	385	357	330	313	297	286	275	264	247	236	225	209
478	627	502	439	408	376	357	339	326	314	301	282	270	257	238
577	757	606	530	492	454	431	409	394	378	363	341	325	310	288
666	874	699	612	568	524	498	472	454	437	420	393	376	358	332
825	973	779	682	633	584	555	526	506	487	468	438	419	399	370

Current carrying capacity

of RADOX® multi core cables

Installation method	Multicore cables in free air or perforated trays											
Number of simultaneous loaded conductors on each tray												
	1	2	3	4	6	8	10	16	20	4	6	
Reduction factor f_5	1	0.87	0.81	0.78	0.75	0.74	0.73	0.72	0.71	0.71	0.62	
Copper conductor cross section mm^2	Current carrying capacity A											
	0.50	14.5	12.6	11.7	11.3	10.9	10.7	10.6	10.4	10.3	10.3	9.0
	0.75	18.5	16.1	15.0	14.4	13.9	13.7	13.5	13.3	13.1	13.1	11.5
	1.0	22	19.1	17.8	17.2	16.5	16.3	16.1	15.8	15.6	15.6	13.6
	1.5	28	25	23	22	21	21	21	21	20	20	18
	2.5	38	34	31	30	29	29	28	28	27	27	24
	4	51	44	42	40	39	38	38	37	37	37	32
	6	66	58	54	52	50	49	49	48	47	47	41
	10	95	83	77	75	72	71	70	69	68	68	59
	16	128	112	104	100	96	95	94	93	91	91	80
	25	167	146	136	131	126	124	122	121	119	119	104
	35	205	179	167	160	154	152	150	148	146	146	128
	50	257	224	209	201	193	191	188	186	183	183	160
	70	325	283	264	254	244	241	238	234	231	231	202
95	382	333	310	298	287	283	279	276	272	272	237	
120	443	386	359	346	333	328	324	319	315	315	275	

Continuous current rating

conductor temperature 120 °C, ambient temperature 30 °C

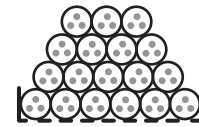

8	10	16	20	4	6	8	10	16	20	4	6	8	10	16	20
0.57	0.53	0.47	0.45	0.67	0.59	0.54	0.50	0.45	0.43	0.71	0.58	0.52	0.48	0.41	0.38

8.3	7.7	6.8	6.5	9.7	8.6	7.8	7.3	6.5	6.2	10.3	8.4	7.5	7.0	5.9	5.5
10.5	9.8	8.7	8.3	12.4	10.9	10.0	9.3	8.3	8.0	13.1	10.7	9.6	8.9	7.6	7.0
12.5	11.7	10.3	9.9	14.7	13.0	11.9	11.0	9.9	9.5	15.6	12.8	11.4	10.6	9.0	8.4
16	15	14	13	19	17	16	14	13	13	20	17	15	14	12	11
22	21	18	18	26	23	21	19	18	17	27	23	20	19	16	15
30	28	24	23	35	31	28	26	23	22	37	30	27	25	21	20
38	35	32	30	45	39	36	33	30	29	47	39	35	32	28	26
55	51	45	43	64	57	52	48	43	41	68	56	50	46	39	37
73	68	61	58	86	76	70	64	58	56	91	75	67	62	53	49
96	89	79	76	112	99	91	84	76	72	119	97	87	81	69	64
117	109	97	93	138	121	111	103	93	89	146	119	107	99	85	78
147	137	121	116	173	152	139	129	116	111	183	150	134	124	106	98
186	173	153	147	218	192	176	163	147	140	231	189	169	156	134	124
218	203	180	172	256	226	207	191	172	165	272	222	199	184	157	146
253	235	209	200	297	262	240	222	200	191	315	257	231	213	182	169

Current carrying capacity

of RADOX® multi core cables

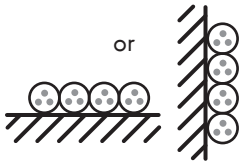
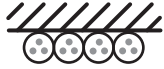
Installation method	on floor or wall				fixed on a ceiling or under floor							
Number of simultaneous loaded conductors on each tray												
	1	2	3	4	1	2	3	4	5	6	7	8
Reduction factor f_5	1	0.87	0.79	0.75	0.95	0.81	0.72	0.68	0.66	0.64	0.63	0.62
Copper conductor cross section mm^2	Current carrying capacity A											
0.50	13.5	11.5	10.7	10.1	12.8	10.9	9.7	9.2	8.9	8.6	8.5	8.4
0.75	17	14.5	13.4	12.8	16.2	13.8	12.2	11.6	11.2	10.9	10.7	10.5
1.0	20	17.0	15.8	15.0	19.0	16.2	14.4	13.6	13.2	12.8	12.6	12.4
1.5	26	23	21	20	25	22	19	18	18	17	17	17
2.5	35	30	28	27	34	29	26	24	24	23	23	22
4	48	41	38	36	46	39	35	33	32	31	31	30
6	62	53	49	47	59	51	45	43	41	40	40	39
10	88	75	70	66	84	72	64	60	59	57	56	55
16	116	99	92	87	111	94	84	79	77	75	74	72
25	154	131	122	116	147	125	111	105	102	99	98	96
35	190	162	151	143	181	154	137	130	126	122	120	118
50	239	204	189	180	228	194	173	163	158	153	151	149
70	299	255	237	225	285	243	216	204	198	192	189	186
95	351	299	278	264	334	285	253	239	232	225	222	218
120	405	345	320	304	385	329	292	276	268	260	256	252

Continuous current rating

conductor temperature 120 °C, ambient temperature 30 °C

in conduit, in a void or in a pipe

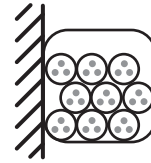
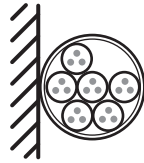

≥9	1	2	3	4	5	6	7	8	9	10	12	14	16	20
0.61	1	0.80	0.70	0.65	0.60	0.57	0.54	0.52	0.50	0.48	0.45	0.43	0.41	0.38

8.2	10.8	8.6	7.6	7.0	6.5	6.2	5.8	5.6	5.4	5.2	4.9	4.6	4.4	4.1
10.4	13.6	10.9	9.5	8.8	8.2	7.8	7.3	7.1	6.8	6.5	6.1	5.8	5.6	5.2
12.2	15.8	12.6	11.1	10.3	9.5	9.0	8.5	8.2	7.9	7.6	7.1	6.8	6.5	6.0
16	21	17	15	14	13	12	12	11	11	11	10	10	9	8
22	28	23	20	19	17	16	16	15	14	14	13	13	12	11
30	38	31	27	25	23	22	21	20	19	19	18	17	16	15
38	48	39	34	32	29	28	26	25	24	24	22	21	20	19
54	67	54	47	44	41	39	37	35	34	33	31	29	28	26
71	89	72	63	58	54	51	49	47	45	43	41	39	37	34
94	119	96	84	78	72	68	65	62	60	58	54	52	49	46
116	147	118	103	96	89	84	80	77	74	71	67	64	61	56
146	184	148	129	120	111	105	100	96	92	89	83	80	76	70
183	234	188	164	153	141	134	127	122	117	113	106	101	96	89
215	275	220	193	179	165	157	149	143	138	132	124	119	113	105
248	338	271	237	220	203	193	183	176	169	163	153	146	139	129

Further catalogues

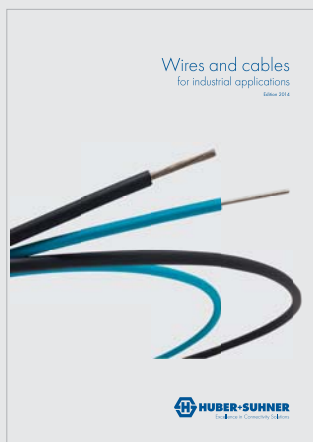

Wires and cables
for industrial applications

Item Nr. 84047253

HUBER+SUHNER AG
Low Frequency Division
Tumbelenstrasse 20
8330 Pfäffikon ZH
Switzerland
Phone +41 44 952 2211
Fax +41 44 952 2670
hubersuhner.com

HUBER+SUHNER is certified according to EN(AS) 9100, ISO 9001, ISO 14001, ISO/TS 16949 and IRIS.

Waiver

Fact and figures herein are for information only and do not represent any warranty of any kind.

